

Inverter

Inverter Drives 8400 HighLine

0.25 to 45 kW



kabea GmbH innovative Antriebe

Koßmannstraße 47 • D-66538 Neunkirchen • Deutschland

Tel: +49 (0)6821/919238 • Fax: +49 (0)6821/919239

Email: becker@kabea-gmbh.de • www.becker-antriebstechnik.org



Inverter Drives 8400 HighLine

Contents



General information	Product key	4.6 - 4	
	Equipment	4.6 - 5	
	List of abbreviations	4.6 - 6	
	Inverter Drives 8400	4.6 - 7	
	Functions and features	4.6 - 8	
	Operating modes	4.6 - 9	
Technical data	Standards and operating conditions	4.6 - 11	
	Rated data 230 V	4.6 - 12	
	Rated data 400 V	4.6 - 18	
	"Cold plate" design	4.6 - 30	
	Push-through technique design	4.6 - 32	
Interfaces	Mains connection	4.6 - 35	
	Motor connection	4.6 - 37	
	Connection diagrams	4.6 - 41	
	Control connections	4.6 - 43	
	Memory module	4.6 - 45	
	Safety system (STO)	4.6 - 45	
	EtherCAT® communication module	4.6 - 46	
	EtherNet/IP communication module	4.6 - 48	
	POWERLINK communication module	4.6 - 50	
	PROFIBUS communication module	4.6 - 52	
	PROFINET communication module	4.6 - 54	
	Accessories	Brake resistors	4.6 - 57
Mains chokes		Operation at rated power	4.6 - 59
		Operation with increased power output	4.6 - 60
Interference suppression		Available RFI and mains filters	4.6 - 61
		Operation at rated power	4.6 - 62
		Operation with increased power output	4.6 - 64
Sinusoidal filters		Operation at rated power	4.6 - 66
		Operation with increased power output	4.6 - 67
Regenerative power supply modules		Rated data for power supply modules	4.6 - 68
		Rated data for regenerative power supply modules	4.6 - 70
		Control connections	4.6 - 72
		Brake resistors of the regenerative power supply modules	4.6 - 73
		Mains chokes of the power supply modules	4.6 - 74
		Interference suppression of the regenerative power supply modules	4.6 - 75
		DC input module	4.6 - 78
		DC-bus connection	4.6 - 79
		24 V power supply unit	4.6 - 81
		Brake switch	4.6 - 81
USB diagnostic adapter		4.6 - 82	
X400 keypad		4.6 - 83	
X400 diagnosis terminal		4.6 - 83	
PC system bus adapter		4.6 - 84	
Shield mounting	4.6 - 84		
Terminal strips	4.6 - 85		
Setpoint potentiometer	4.6 - 86		

Inverter Drives 8400 HighLine

General information



Product key

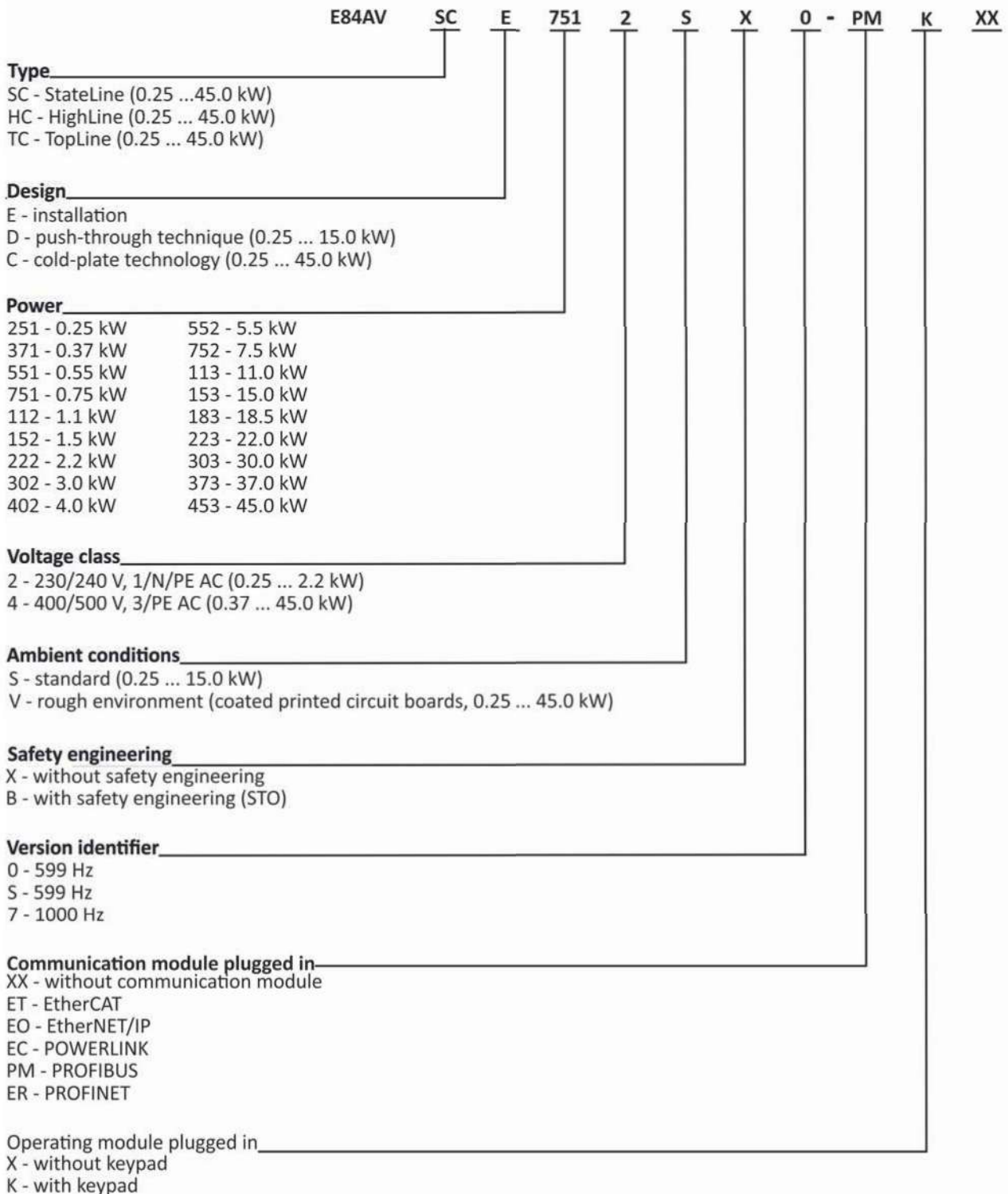

4.6

Inverter Drives 8400 HighLine

General information



Equipment

X100 Mains connection

X100 DC-bus connection
(400 V types)

IT screw

X101 Relay connection

Communication module
Option

Safety engineering (STO)
Option

Memory module
• pluggable
• contains all drive data

X6 Diagnostic interface
USB adapter for
PC connection,
keypad (option)

X3 Control terminal
Spring-applied brake

X5 Control terminal
Spring-applied brake

X1 CANopen on board
• DS301-compliant
• T-plug

X107 Integrated shield connection
Control cables

Integrated shield connection
Motor cable

X4 Control terminal
Spring-applied brake

X105 Motor connection

X80 Safety engineering (STO)
Option

Integrated shield connection
Control cable



4.6



List of abbreviations

b	[mm]	Dimensions
C _{th}	[KW]s	Thermal capacity
f _{ch}	[kHz]	Switching frequency
h	[mm]	Dimensions
H _{max}	[m]	Site altitude
I _{max}	[A]	Max. DC-bus current
I _{max, out}	[A]	Max. output current
I _{N, AC}	[A]	Rated mains current
I _{N, DC}	[A]	Rated DC-bus current
I _{N, out}	[A]	Rated output current
l _{max}	[m]	Max. cable length
m	[kg]	Mass
P	[kW]	Typical motor power
P _{max, 1}	[kW]	Max. output power
P _V	[kW]	Power loss
P _N	[kW]	Rated power
R _{min}	[Ω]	Min. brake resistance
R _N	[Ω]	Rated resistance
t	[mm]	Dimensions
U _{AC}	[V]	Mains voltage
U _{DC}	[V]	DC supply
U _{N, AC}	[V]	Rated voltage
U _{out}	[V]	Max. output voltage

ASM	Asynchronous motor
DIAG	Slot for diagnostic adapter
DIN	Deutsches Institut für Normung e.V.
EN	European standard
EN 60529	Degrees of protection provided by enclosures (IP code)
EN 60721-3	Classification of environmental conditions; Part 3: Classes of environmental parameters and their limit values
EN 61800-3	Electrical variable speed drives Part 3: EMC requirements including special test methods
IEC	International Electrotechnical Commission
IEC 61508	Functional safety of electrical/electronic/programmable electronic safety-related systems
IM	International Mounting Code
IP	International Protection Code
MCI	Slot for communication module (module communication interface)
NEMA	National Electrical Manufacturers Association
UL	Underwriters Laboratory Listed Product
UR	Underwriters Laboratory Recognized Product
VDE	Verband deutscher Elektrotechniker (Association of German Electrical Engineers)

Inverter Drives 8400 HighLine

General information



Inverter Drives 8400

Cost-efficiency, time savings and quality enhancement are the challenges of the future. Lenze is facing these challenges with its L-force product portfolio – the holistic solution portfolio with precisely matched interfaces and components. For faster configuration and commissioning, better performance and more flexibility in production.

As such, the four versions of Inverter Drives 8400 - BaseLine, StateLine, HighLine and TopLine - have been designed for consistent process optimisation – throughout your entire value-added chain. They reduce your costs, from component selection, through project planning, manufacturing and commissioning, all the way up to servicing. We call this "rightsizing".

Rightsized for versatile applications

Are you looking to control a three-phase AC motor or perform positioning with or without feedback? Then select exactly the inverter you need from the scaled solution space of the Inverter Drives 8400 with units in the power range from 0.25 kW to 45 kW. You are sure to find exactly what you are looking for here, as the modular 8400 range of inverters offers the right solution for a broad spectrum of applications.

While the BaseLine is excellent for basic applications, the TopLine offers servo qualities and thereby fulfils with the strict requirements in terms of dynamics and accuracy.

Rightsized for optimised operation

The energy-saving function "VFC eco" supported by the 8400 reduces the energy required by the motor in partial load operation. Combine this with an MF L-force three-phase AC motor (inverter-optimised, 120 Hz) and what you get is a highly efficient, compact and cost-effective drive with high dynamic performance and a wide setting range. "VFC eco" can reduce your energy costs by up to 30%.

8400 HighLine - for positioning tasks

Alongside the options offered by the 8400 StateLine, the additional features of the 8400 HighLine include integrated point-to-point positioning. As such, up to 15 selectable target positions, including the corresponding travel profile (e.g. acceleration), can be stored in the inverter. These positions are selected and corresponding procedures specified by the master control. The returned incremental encoder signal is evaluated via two digital inputs, whereby many applications do not require feedback.

The 8400 HighLine is recommended for applications such as rotary indexing tables, rolling and sliding doors or positioning tasks in storage systems.

Inverter Drives 8400 HighLine

General information



Functions and features

Mode	8400 HighLine
Control types, motor control	
Field-oriented servo control (SC)	For asynchronous servo motors and three-phase asynchronous motors
Sensorless control (SLPSM)	For synchronous servo motors
Sensorless vector control (SLVC)	For three-phase asynchronous motors
V/f control (VFCplus)	For three-phase AC motors and asynchronous servo motor (linear or square-law)
Energy saving function (VFC eco)	For three-phase asynchronous motors
Basic functions	<ul style="list-style-type: none"> Freely assignable user menu Free function block interconnection with extensive function library Parameter change-over DC brake function Braking operation without brake resistor Brake management for brake control with low rate of wear Flying restart circuit S-shaped ramps for smooth acceleration PID controller 15 fixed frequencies Masking frequencies Inversion of motor phase sequence
Technology applications	<ul style="list-style-type: none"> Speed actuating drive Switch-off positioning without feedback Table positioning without feedback
Monitoring and protective measures	<ul style="list-style-type: none"> Short circuit Earth fault Overvoltage Motor phase failure Overcurrent I² x t-Motor monitoring Motor overtemperature Mains phase failure Protection against restart for cyclic mains switching Motor stalling
Diagnostics	Data logger, logbook, oscilloscope functions
Status display	4 LEDs
Diagnostic interface	Integrated For USB diagnostic adapter or keypad (diagnosis terminal)
Braking operation	
Brake chopper	Integrated
Brake resistor	External

4.6

Inverter Drives 8400 HighLine

General information



Operating modes

An inverter enables energy-efficient operation of a system in virtually all application cases. The various operating modes, which can be created by making just a few simple settings, facilitate this. The following characteristics and corresponding specifications listed on the following pages can be used to calculate the optimum operating mode during the project planning phase.

Standard setting

In its initial state when delivered, the inverter is set up for basic operation with a three-phase AC motor with V/f control. When operated in this mode, the rated torque of the motor is available in a setting range up to 50 Hz.

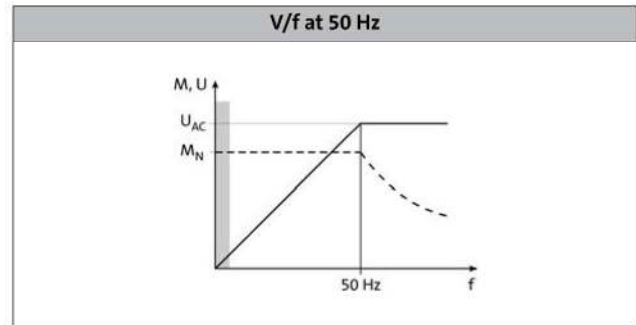

Extended setting range up to 87 Hz

If the V/f reference point on the inverter is set to 87 Hz, the rated torque can be used across an extended setting range. Here, a 230/400V motor is for example used and operated in a delta layout with a 400V inverter. The setting range is then increased by 40 %. The inverter must be dimensioned for a rated motor current of 230 V.

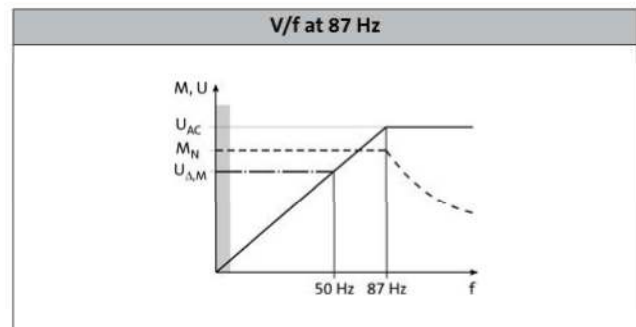

Operation with inverter-optimised MF motors

Large setting ranges and optimum operation at the rated torque: these are the strengths of the MF motor when used in combination with an inverter. The motors are optimised for a setting range up to 120 Hz. Compared to conventional 50Hz operation, the setting range increases by 250 %. It is quite simply not possible for a drive to be operated any more efficiently in a machine.

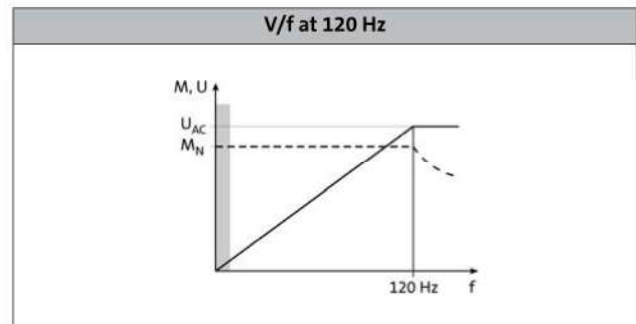



Operating modes

Square-law V/f characteristic control

The output voltage is increased quadratically to the output frequency. In case of low output frequencies, the motor voltage can be increased to ensure a minimum current for the breakaway torque. In the field weakening range, the output voltage of the inverter is constant (mains voltage) and the frequency can be further increased depending on the load. The maximum torque of the motor is reduced quadratically to the frequency increase, the maximum output power of the motor being constant.

Application areas are for instance:

- Pumps
- Blowers
- Fans

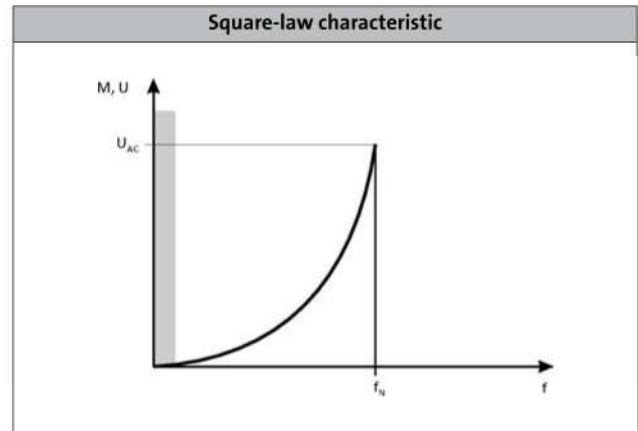

VFCeco energy saving mode

The VFCeco mode has a special effect in the partial load operational range. Usually, three-phase AC motors are supplied there with a higher magnetising current than required by the operating conditions. The VFCeco mode reduces the losses in the partial load operational range so that savings up to 30 % are possible.

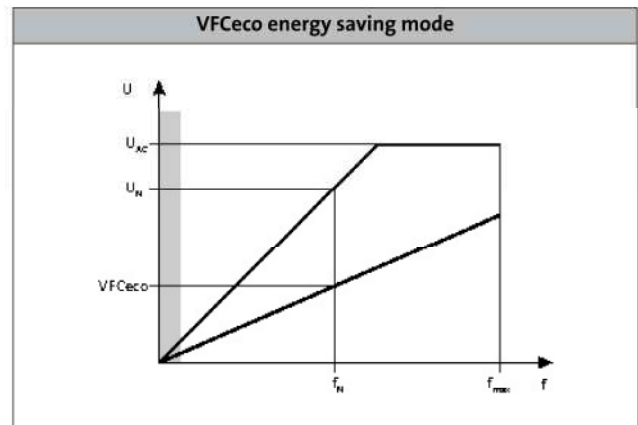

Overcurrent operation

The inverters can be driven at higher amperages beyond the rated current if the duration of this overcurrent operation is time limited. Two utilisation cycles with a duration of 15 s and 180 s are defined. Within these utilisation cycles, an overcurrent is possible for a certain time if afterwards an accordingly long recovery phase takes place. For both utilisation cycles, a moving average is determined separately. The adjacent diagram shows both cycles: 15 s in red and 180 s in blue. The overload times t_{O1} are 3 s (T_1) and 60 s (T_3) respectively, the corresponding recovery times t_{re} are 12 s (T_2) and 120 s (T_4) respectively. The following tables show the resulting maximum output currents. Monitoring of the device utilisation ($I \times t$) activates the set error response (trip or warning) if one of the two utilisation values exceeds the limit of 100 %.

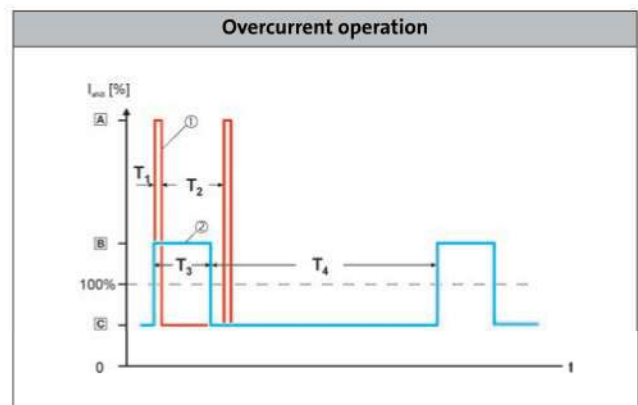

Inverter Drives 8400 HighLine

Technical data



Standards and operating conditions

Mode			
Product			8400 HighLine
Conformity			
CE			Low-Voltage Directive 2006/95/EC
EAC			TP TC 004/2011 (TR CU 004/2011) TP TC 020/2011 (TR CU 020/2011)
Approval			
UL 508C			for USA and Canada (requirements of the CSA 22.2 No. 14) ²⁾ Power Conversion Equipment (file no. E132659)
Degree of protection			
EN 60529 ³⁾			IP20
NEMA 250			Type 1
Climatic conditions			
Storage (EN 60721-3-1)			1K3 (temperature: -25 °C ... +60 °C)
Transport (EN 60721-3-2)			2K3 (temperature: -25 °C ... +70 °C)
Operation (EN 60721-3-3)			3K3 (temperature: -10°C ... +55 °C)
Current derating at over 45°C			2.5% / K
Site altitude			
Amsl	H _{max}	[m]	4000
Current derating at over 1000 m		[%/1000 m]	5
Vibration resistance			
Transport (EN 60721-3-2)			2M2
Operation (EN 61800-5-1)			10 Hz ≤ f ≤ 57 Hz: ±0.075 mm amplitude, 57 Hz ≤ f ≤ 150 Hz: 1.0 g
Operation (Germanischer Lloyd)			5 Hz ≤ f ≤ 13.2 Hz: ± 1 mm amplitude 13.2 Hz ≤ f ≤ 100 Hz: 0.7 g

4.6

Mode			
Product			8400 HighLine
Supply form			
			Systems with earthed star point (TN and TT systems) Systems with high-resistance or isolated star point (IT systems)
Noise emission			
EN 61800-3			Integrated RFI suppression: category C2 up to 25 m shielded motor cable ¹⁾
Insulation resistance			
EN 61800-5-1			Overvoltage category III Above 2000 m amsl overvoltage category II
Degree of pollution			
EN 61800-5-1			2
Protective insulation of control circuits			
EN 61800-5-1			Safe mains isolation: double/reinforced insulation

¹⁾ 37 - Please also refer to the Motor connection section

²⁾ CSA when using an external mains choke or a module for reducing transients.

³⁾ Mounted and ready-to-use

Inverter Drives 8400 HighLine

Technical data



Rated data 230 V

► Unless otherwise specified, the data refers to the default setting.

Data in left column per device

Operation with rated data: rated output current $I_{N,out}$ at a mains voltage 230 V, switching frequency 8 kHz variable and an ambient temperature 45 °C (default setting).
Output currents I_{out} apply to:
Ambient temperature 45 °C operating with constant switching frequency 2 kHz or 4 kHz.
Ambient temperature 40 °C operating with constant switching frequency 8 kHz or 16 kHz.

Data in right column per device

Operation with increased power: rated output current $I_{N,out}$ at mains voltage 230 V, switching frequency 4 kHz and max. ambient temperature 40 °C.
Output currents apply to:
Ambient temperature 40 °C operating with switching frequency 2 kHz or 4 kHz.

						
Typical motor power						
4-pole asynchronous motor	P	[kW]	0.25	0.37	0.37	0.55 ¹⁾
Product key			E84AVHC□2512□□0		E84AVHC□3712□□0	
Mains voltage range			1/N/PE AC 180 V-0 % ... 264 V+0 %, 45 Hz-0 % ... 65 Hz+0 %			
Rated mains current						
With mains choke	$I_{N,AC}$	[A]	3.0	3.6	4.2	5.0
Without mains choke	$I_{N,AC}$	[A]	3.4	4.1	5.0	
Rated output current						
	$I_{N,out}$	[A]	1.7	2.1	2.4	2.9
Output current						
2 kHz	I_{out}	[A]	1.7	2.1	2.4	2.9
4 kHz	I_{out}	[A]	1.7	2.1	2.4	2.9
8 kHz	I_{out}	[A]	1.7		2.4	
16 kHz	I_{out}	[A]	1.1		1.6	

Data for 60 s overload

Max. output current						
	$I_{max,out}$	[A]	2.6		3.6	
Overload time						
	t_{ol}	[s]		60.0		
Recovery time						
	t_{re}	[s]		120.0		

Data for 3 s overload

Max. short-time output current						
	$I_{max,out}$	[A]	3.4		4.8	
Overload time						
	t_{ol}	[s]		3.0		
Recovery time						
	t_{re}	[s]		12.0		

¹⁾ Operation only permitted with mains choke

Inverter Drives 8400 HighLine

Technical data



Rated data 230 V

► Unless otherwise specified, the data refers to the default setting.

						
Typical motor power						
4-pole asynchronous motor	P	[kW]	0.25	0.37	0.37	0.55
Product key			E84AVHC□2512□□0		E84AVHC□3712□□0	
Power loss						
	P _V	[kW]	0.045		0.050	
Max. cable length¹⁾						
Shielded motor cable	I _{max}	[m]	50			

Brake chopper rated data

Rated power, Brake chopper				
	P _N	[kW]	0.6	0.6
Max. output power, Brake chopper				
	P _{max,1}	[kW]	0.8	0.8
Min. brake resistance				
	R _{min}	[Ω]	180.0	180.0

4.6

Dimensions and weights

Standard installation design

Dimensions				
Height	h	[mm]	165	165
Width	b	[mm]	70	70
Depth ²⁾	t	[mm]	199	199
Mass				
	m	[kg]	1.3	1.3

¹⁾ Technically possible cable lengths, irrespective of EMC requirements

²⁾ With safety engineering plus 20 mm

Inverter Drives 8400 HighLine

Technical data



Rated data 230 V

► Unless otherwise specified, the data refers to the default setting.

Data in left column per device

Operation with rated data: rated output current $I_{N,out}$ at a mains voltage 230 V, switching frequency 8 kHz variable and an ambient temperature 45 °C (default setting).
Output currents I_{out} apply to:
Ambient temperature 45 °C operating with constant switching frequency 2 kHz or 4 kHz.
Ambient temperature 40 °C operating with constant switching frequency 8 kHz or 16 kHz.

Data in right column per device

Operation with increased power: rated output current $I_{N,out}$ at mains voltage 230 V, switching frequency 4 kHz and max. ambient temperature 40 °C.
Output currents apply to:
Ambient temperature 40 °C operating with switching frequency 2 kHz or 4 kHz.

Typical motor power						
4-pole asynchronous motor	P	[kW]	0.55	0.75	0.75	1.10 ¹⁾
Product key			E84AVHC□5512□□0 E84AVHC□5512□□S		E84AVHC□7512□□0 E84AVHC□7512□□S	
Mains voltage range			1/N/PE AC 180 V-0 % ... 264 V+0 %, 45 Hz-0 % ... 65 Hz+0 %			
Rated mains current						
With mains choke	$I_{N, AC}$	[A]	5.0	6.0	7.0	8.4
Without mains choke	$I_{N, AC}$	[A]	5.3	6.4	8.0	
Rated output current						
	$I_{N, out}$	[A]	3.0	3.6	4.0	4.8
Output current						
2 kHz	I_{out}	[A]	3.0	3.6	4.0	4.8
4 kHz	I_{out}	[A]	3.0	3.6	4.0	4.8
8 kHz	I_{out}	[A]	3.0		4.0	
16 kHz	I_{out}	[A]	2.0		2.7	

Data for 60 s overload

Max. output current			4.5		6.0	
	$I_{max, out}$	[A]				
Overload time			60.0			
	t_{ol}	[s]				
Recovery time			120.0			
	t_{re}	[s]				

Data for 3 s overload

Max. short-time output current			6.0		8.0	
	$I_{max, out}$	[A]				
Overload time			3.0			
	t_{ol}	[s]				
Recovery time			12.0			
	t_{re}	[s]				

¹⁾ Operation only permitted with mains choke

Inverter Drives 8400 HighLine

Technical data



Rated data 230 V

► Unless otherwise specified, the data refers to the default setting.

						
Typical motor power						
4-pole asynchronous motor	P	[kW]	0.55	0.75	0.75	1.10
Product key			E84AVHC□5512□□0 E84AVHC□5512□□S		E84AVHC□7512□□0 E84AVHC□7512□□S	E84AVHC□7512□□0 E84AVHCC7512□□S
Power loss						
	P _V	[kW]	0.060		0.075	
Max. cable length¹⁾						
Shielded motor cable	I _{max}	[m]	50			

Brake chopper rated data

Rated power, Brake chopper				
	P _N	[kW]	1.1	1.1
Max. output power, Brake chopper				
	P _{max,1}	[kW]	1.4	1.4
Min. brake resistance				
	R _{min}	[Ω]	100.0	100.0

Dimensions and weights

Standard installation design

Dimensions				
Height	h	[mm]	215	215
Width	b	[mm]	70	70
Depth ²⁾	t	[mm]	199	199
Mass				
	m	[kg]	1.8	1.8

¹⁾ Technically possible cable lengths, irrespective of EMC requirements

²⁾ With safety engineering plus 20 mm

Inverter Drives 8400 HighLine

Technical data



Rated data 230 V

► Unless otherwise specified, the data refers to the default setting.

Data in left column per device

Operation with rated data: rated output current $I_{N,out}$ at a mains voltage 230 V, switching frequency 8 kHz variable and an ambient temperature 45 °C (default setting).
Output currents I_{out} apply to:
Ambient temperature 45 °C operating with constant switching frequency 2 kHz or 4 kHz.
Ambient temperature 40 °C operating with constant switching frequency 8 kHz or 16 kHz.

Data in right column per device

Operation with increased power: rated output current $I_{N,out}$ at mains voltage 230 V, switching frequency 4 kHz and max. ambient temperature 40 °C.
Output currents apply to:
Ambient temperature 40 °C operating with switching frequency 2 kHz or 4 kHz.

							
Typical motor power							
4-pole asynchronous motor	P	[kW]	1.10	1.10	1.50	2.20 ¹⁾	2.20
Product key			E84AVHC□1122□□0 E84AVHC□1122□□S		E84AVHC□1522□□0 E84AVHC□1522□□S		E84AVHC□2222□□0 E84AVHC□2222□□S
Mains voltage range			1/N/PE AC 180 V-0 % ... 264 V+0 %, 45 Hz-0 % ... 65 Hz+0 %				
Rated mains current							
With mains choke	$I_{N, AC}$	[A]	9.9	11.9	11.4	13.7	16.4
Without mains choke	$I_{N, AC}$	[A]	12.0	14.4	13.7		21.8
Rated output current							
	$I_{N, out}$	[A]	5.5	6.8	7.0	8.4	9.5
Output current							
2 kHz	I_{out}	[A]	5.5	6.8	7.0	8.4	9.5
4 kHz	I_{out}	[A]	5.5	6.8	7.0	8.4	9.5
8 kHz	I_{out}	[A]	5.5		7.0		9.5
16 kHz	I_{out}	[A]	3.7		4.7		6.3

Data for 60 s overload

Max. output current							
	$I_{max, out}$	[A]	8.3		10.5		14.3
Overload time							
	t_{ol}	[s]	60.0				
Recovery time							
	t_{re}	[s]	120.0				

Data for 3 s overload

Max. short-time output current							
	$I_{max, out}$	[A]	11.0		14.0		19.0
Overload time							
	t_{ol}	[s]	3.0				
Recovery time							
	t_{re}	[s]	12.0				

¹⁾ Operation only permitted with mains choke

Inverter Drives 8400 HighLine

Technical data



Rated data 230 V

► Unless otherwise specified, the data refers to the default setting.

Typical motor power							
4-pole asynchronous motor	P	[kW]	1.10	1.50	1.50	2.20	2.20
Product key			E84AVHC□1122□□0 E84AVHC□1122□□S		E84AVHC□1522□□0 E84AVHC□1522□□S		E84AVHC□2222□□0 E84AVHC□2222□□S
Power loss							
	P _V	[kW]	0.095		0.110		0.140
Max. cable length¹⁾							
Shielded motor cable	I _{max}	[m]	50				

Brake chopper rated data

Rated power, Brake chopper					
	P _N	[kW]	3.3	3.3	3.3
Max. output power, Brake chopper					
	P _{max, 1}	[kW]	4.4	4.4	4.4
Min. brake resistance					
	R _{min}	[Ω]	33.0	33.0	33.0

4.6

Dimensions and weights

Standard installation design

Dimensions					
Height	h	[mm]	270	270	270
Width	b	[mm]	70	70	70
Depth ²⁾	t	[mm]	199	199	199
Mass					
	m	[kg]	2.1	2.1	2.1

¹⁾ Technically possible cable lengths, irrespective of EMC requirements

²⁾ With safety engineering plus 20 mm

Inverter Drives 8400 HighLine

Technical data



Rated data 400 V

► Unless otherwise specified, the data refers to the default setting.

Data in left column per device

Operation with rated data: rated output current $I_{N,out}$ at mains voltage 400 V, switching frequency 8 kHz variable and max. ambient temperature 45 °C (default setting).
Output currents I_{out} apply to:
Ambient temperature 45 °C operating with constant switching frequency 2 kHz or 4 kHz.
Ambient temperature 40 °C operating with constant switching frequency 8 kHz or 16 kHz.

Data in right column per device

Operation with increased power: rated output current $I_{N,out}$ at mains voltage 400 V, switching frequency 4 kHz constant and max. ambient temperature 40 °C.
Output currents apply to:
Ambient temperature 40 °C operating with constant switching frequency 2 kHz or 4 kHz.

Typical motor power								
4-pole asynchronous motor	P	[kW]	0.37	0.55	0.55	0.75	0.75	1.10 ¹⁾
Product key			E84AVHC□3714□□0 E84AVHC□3714□□S		E84AVHC□5514□□0 E84AVHC□5514□□S		E84AVHC□7514□□0 E84AVHC□7514□□S	
Mains voltage range			3/PE AC 320 V-0 % ... 550 V+0 %, 45 Hz-0 % ... 65 Hz+0 %					
Rated mains current								
With mains choke	$I_{N, AC}$	[A]	1.4	1.7	2.0	2.6		3.0
Without mains choke	$I_{N, AC}$	[A]	1.8	2.2	2.5	3.2	3.6	
Rated output current								
	$I_{N, out}$	[A]	1.3	1.6	1.8	2.2	2.4	2.9
Output current								
2 kHz	I_{out}	[A]	1.3	1.6	1.8	2.2	2.4	2.9
4 kHz	I_{out}	[A]	1.3	1.6	1.8	2.2	2.4	2.9
8 kHz	I_{out}	[A]	1.3		1.8		2.4	
16 kHz	I_{out}	[A]	0.9		1.2		1.6	

Data for 60 s overload

Max. output current								
	$I_{max, out}$	[A]	2.0		2.7		3.6	
Overload time								
	t_{ol}	[s]	60.0					
Recovery time								
	t_{re}	[s]	120.0					

Data for 3 s overload

Max. short-time output current								
	$I_{max, out}$	[A]	2.6		3.6		4.8	
Overload time								
	t_{ol}	[s]	3.0					
Recovery time								
	t_{re}	[s]	12.0					

¹⁾ Operation only permitted with mains choke

Inverter Drives 8400 HighLine

Technical data



Rated data 400 V

► Unless otherwise specified, the data refers to the default setting.

Typical motor power								
4-pole asynchronous motor	P	[kW]	0.37	0.55	0.55	0.75	0.75	1.10
Product key			E84AVHC□3714□□0 E84AVHC□3714□□S		E84AVHC□5514□□0 E84AVHC□5514□□S		E84AVHC□7514□□0 E84AVHC□7514□□S	
DC supply			DC 455 V -0 % ... 775 V +0 %					
Rated DC-bus current	U_{DC}	[V]						
	$I_{N, DC}$	[A]	2.2		3.3		4.4	
Power loss								
	P_V	[kW]	0.050		0.065		0.080	
Max. cable length¹⁾								
Shielded motor cable	I_{max}	[m]	50					

Brake chopper rated data

Rated power, Brake chopper					
	P_N	[kW]	1.3	1.3	1.3
Max. output power, Brake chopper					
	$P_{max, 1}$	[kW]	1.3	1.3	1.3
Min. brake resistance					
	R_{min}	[Ω]	390.0	390.0	390.0

Dimensions and weights

Standard installation design

Dimensions					
Height	h	[mm]	215	215	215
Width	b	[mm]	70	70	70
Depth ²⁾	t	[mm]	199	199	199
Mass					
	m	[kg]	1.8	1.8	1.8

¹⁾ Technically possible cable lengths, irrespective of EMC requirements

²⁾ With safety engineering plus 20 mm

Inverter Drives 8400 HighLine

Technical data



Rated data 400 V

► Unless otherwise specified, the data refers to the default setting.

Data in left column per device

Operation with rated data: rated output current $I_{N,out}$ at mains voltage 400 V, switching frequency 8 kHz variable and max. ambient temperature 45 °C (default setting).
Output currents I_{out} apply to:
Ambient temperature 45 °C operating with constant switching frequency 2 kHz or 4 kHz.
Ambient temperature 40 °C operating with constant switching frequency 8 kHz or 16 kHz.

Data in right column per device

Operation with increased power: rated output current $I_{N,out}$ at mains voltage 400 V, switching frequency 4 kHz constant and max. ambient temperature 40 °C.
Output currents apply to:
Ambient temperature 40 °C operating with constant switching frequency 2 kHz or 4 kHz.

Typical motor power										
4-pole asynchronous motor	P	[kW]	1.10	1.50	1.50	2.20	2.20	3.00 ¹⁾	3.00	4.00 ¹⁾
Product key			E84AVHC□1124□□0 E84AVHCC1124□□S		E84AVHC□1524□□0 E84AVHCC1524□□S		E84AVHC□2224□□0 E84AVHCC2224□□S		E84AVHC□3024□□S	
Mains voltage range										
	U_{AC}	[V]	3/PE AC 320 V-0 % ... 550 V+0 %, 45 Hz-0 % ... 65 Hz+0 %							
Rated mains current										
With mains choke	$I_{N, AC}$	[A]	3.2	3.8	3.9	4.7	5.1	6.1	7.0	8.4
Without mains choke	$I_{N, AC}$	[A]	4.4	5.3	5.5	6.6	7.3		9.8	11.8
Rated output current										
	$I_{N, out}$	[A]	3.2	3.8	3.9	4.8	5.6	6.7	7.3	8.8
Output current										
2 kHz	I_{out}	[A]	3.2	3.8	3.9	4.8	5.6	6.7	7.3	8.8
4 kHz	I_{out}	[A]	3.2	3.8	3.9	4.8	5.6	6.7	7.3	8.8
8 kHz	I_{out}	[A]	3.2		3.9		5.6		7.3	
16 kHz	I_{out}	[A]	2.1		2.6		3.7		4.9	

Data for 60 s overload

Max. output current										
	$I_{max, out}$	[A]	4.8		5.9		8.4		11.0	
Overload time										
	t_{ol}	[s]	60.0							
Recovery time										
	t_{re}	[s]	120.0							

Data for 3 s overload

Max. short-time output current										
	$I_{max, out}$	[A]	6.4		7.8		11.2		14.6	
Overload time										
	t_{ol}	[s]	3.0							
Recovery time										
	t_{re}	[s]	12.0							

¹⁾ Operation only permitted with mains choke

Inverter Drives 8400 HighLine

Technical data



Rated data 400 V

► Unless otherwise specified, the data refers to the default setting.

Typical motor power										
4-pole asynchronous motor	P	[kW]	1.10	1.50	1.50	2.20	2.20	3.00	3.00	4.00
Product key			E84AVHC□1124□□0 E84AVHCC1124□□S		E84AVHC□1524□□0 E84AVHCC1524□□S		E84AVHC□2224□□0 E84AVHCC2224□□S		E84AVHC□3024□□S	
DC supply										
	U _{DC}	[V]	DC 455 V -0 % ... 775 V +0 %							
Rated DC-bus current										
	I _{N, DC}	[A]	5.4		6.7		8.9		12.0	
Power loss										
	P _V	[kW]	0.095		0.105		0.135		0.165	
Max. cable length¹⁾										
Shielded motor cable	I _{max}	[m]	50							

Brake chopper rated data

Rated power, Brake chopper						
	P _N	[kW]	2.9	2.9	3.5	6.4
Max. output power, Brake chopper						
	P _{max, 1}	[kW]	2.9	2.9	3.5	6.4
Min. brake resistance						
	R _{min}	[Ω]	180.0	180.0	150.0	82.0

Dimensions and weights

Standard installation design

Dimensions						
Height	h	[mm]	270	270	270	270
Width	b	[mm]	70	70	70	70
Depth ²⁾	t	[mm]	199	199	199	199
Mass						
	m	[kg]	2.1	2.1	2.1	2.0

¹⁾ Technically possible cable lengths, irrespective of EMC requirements

²⁾ With safety engineering plus 20 mm

Inverter Drives 8400 HighLine

Technical data



Rated data 400 V

► Unless otherwise specified, the data refers to the default setting.

Data in left column per device

Operation with rated data: rated output current $I_{N,out}$ at mains voltage 400 V, switching frequency 8 kHz variable and max. ambient temperature 45 °C (default setting).
Output currents I_{out} apply to:
Ambient temperature 45 °C operating with constant switching frequency 2 kHz or 4 kHz.
Ambient temperature 40 °C operating with constant switching frequency 8 kHz or 16 kHz.

Data in right column per device

Operation with increased power: rated output current $I_{N,out}$ at mains voltage 400 V, switching frequency 4 kHz constant and max. ambient temperature 40 °C.
Output currents apply to:
Ambient temperature 40 °C operating with constant switching frequency 2 kHz or 4 kHz.

Typical motor power								
4-pole asynchronous motor	P	[kW]	3.00	4.00	4.00	5.50	5.50	7.50 ¹⁾
Product key			E84AVHC□3024□□□		E84AVHC□4024□□□		E84AVHC□5524□□□	
Mains voltage range			3/PE AC 320 V-0 % ... 550 V+0 %, 45 Hz-0 % ... 65 Hz+0 %					
Rated mains current								
With mains choke	$I_{N,AC}$	[A]	7.0	8.4	8.8	10.6	12.0	18.0
Without mains choke	$I_{N,AC}$	[A]	9.8	11.8	13.1	15.7	18.0	
Rated output current								
	$I_{N,out}$	[A]	7.3	8.8	9.5	11.5	13.0	15.6
Output current								
2 kHz	I_{out}	[A]	7.3	8.8	9.5	11.5	13.0	15.6
4 kHz	I_{out}	[A]	7.3	8.8	9.5	11.5	13.0	15.6
8 kHz	I_{out}	[A]	7.3		9.5		13.0	
16 kHz	I_{out}	[A]	4.9		6.3		8.7	

Data for 60 s overload

Max. output current							
	$I_{max,out}$	[A]	11.0		14.3		19.5
Overload time							
	t_{ol}	[s]			60.0		
Recovery time							
	t_{re}	[s]			120.0		

Data for 3 s overload

Max. short-time output current							
	$I_{max,out}$	[A]	14.6		19.0		26.0
Overload time							
	t_{ol}	[s]			3.0		
Recovery time							
	t_{re}	[s]			12.0		

¹⁾ Operation only permitted with mains choke

Inverter Drives 8400 HighLine

Technical data



Rated data 400 V

► Unless otherwise specified, the data refers to the default setting.

								
Typical motor power								
4-pole asynchronous motor	P	[kW]	3.00	4.00	4.00	5.50	5.50	7.50
Product key			E84AVHC□3024□□0		E84AVHC□4024□□0		E84AVHC□5524□□0	
DC supply			DC 455 V -0 % ... 775 V +0 %					
	U _{DC}	[V]						
Rated DC-bus current			12.0		16.0		22.0	
	I _{N,DC}	[A]						
Power loss			0.165		0.205		0.275	
	P _V	[kW]						
Max. cable length¹⁾			50					
Shielded motor cable	I _{max}	[m]						

Brake chopper rated data

4.6

Rated power, Brake chopper			6.4	9.4	9.4
	P _N	[kW]			
Max. output power, Brake chopper			6.4	11.2	11.2
	P _{max,1}	[kW]			
Min. brake resistance			82.0	47.0	47.0
	R _{min}	[Ω]			

Dimensions and weights

Standard installation design

Product key			E84AVHC□4024□□0	E84AVHC□5524□□0
Dimensions				
Height	h	[mm]	270	270
Width	b	[mm]	140	140
Depth ²⁾	t	[mm]	199	199
Mass				
	m	[kg]	4.4	4.4

¹⁾ Technically possible cable lengths, irrespective of EMC requirements

²⁾ With safety engineering plus 20 mm

Inverter Drives 8400 HighLine

Technical data



Rated data 400 V

► Unless otherwise specified, the data refers to the default setting.

Data in left column per device

Operation with rated data: rated output current $I_{N,out}$ at mains voltage 400 V, switching frequency 8 kHz variable and max. ambient temperature 45 °C (default setting).
Output currents I_{out} apply to:
Ambient temperature 45 °C operating with constant switching frequency 2 kHz or 4 kHz.
Ambient temperature 40 °C operating with constant switching frequency 8 kHz or 16 kHz.

Data in right column per device

Operation with increased power: rated output current $I_{N,out}$ at mains voltage 400 V, switching frequency 4 kHz constant and max. ambient temperature 40 °C.
Output currents apply to:
Ambient temperature 40 °C operating with constant switching frequency 2 kHz or 4 kHz.

							
Typical motor power							
4-pole asynchronous motor	P	[kW]	7.50	11.0	11.0	15.0 ¹⁾	15.0 ¹⁾
Product key			E84AVHC□7524□□□		E84AVHC□1134□□□		E84AVHC□1534□□□
Mains voltage range			3/PE AC 320 V-0 % ... 550 V+0 %, 45 Hz-0 % ... 65 Hz+0 %				
Rated mains current							
With mains choke	$I_{N,AC}$	[A]	15.0	21.0		29.0	
Without mains choke	$I_{N,AC}$	[A]	20.0	28.0	29.0		
Rated output current							
	$I_{N,out}$	[A]	16.5	21.0	23.5	28.2	32.0
Output current							
2 kHz	I_{out}	[A]	16.5	21.0	23.5	28.2	32.0
4 kHz	I_{out}	[A]	16.5	21.0	23.5	28.2	32.0
8 kHz	I_{out}	[A]	16.5		23.5		32.0
16 kHz	I_{out}	[A]	11.0		15.7		21.3

Data for 60 s overload

Max. output current						
	$I_{max,out}$	[A]	26.4		35.3	48.0
Overload time						
	t_{ol}	[s]			60.0	
Recovery time						
	t_{re}	[s]			120.0	

Data for 3 s overload

Max. short-time output current						
	$I_{max,out}$	[A]	33.0		47.0	64.0
Overload time						
	t_{ol}	[s]			3.0	
Recovery time						
	t_{re}	[s]			12.0	

¹⁾ Operation only permitted with mains choke

Inverter Drives 8400 HighLine

Technical data



Rated data 400 V

► Unless otherwise specified, the data refers to the default setting.

							
Typical motor power							
4-pole asynchronous motor	P	[kW]	7.50	11.0	11.0	15.0	15.0
Product key			E84AVHC□7524□□□0		E84AVHC□1134□□□0		E84AVHC□1534□□□0
DC supply			DC 455 V -0 % ... 775 V +0 %				
Rated DC-bus current							
	$I_{N,DC}$	[A]	24.5		35.5		
Power loss							
	P_V	[kW]	0.320		0.435		0.470
Max. cable length ¹⁾							
Shielded motor cable	I_{max}	[m]	50				

Brake chopper rated data

4.6

Rated power, Brake chopper					
	P_N	[kW]	19.5	19.5	29.2
Max. output power, Brake chopper					
	$P_{max,1}$	[kW]	19.5	19.5	29.2
Min. brake resistance					
	R_{min}	[Ω]	27.0	27.0	18.0

Dimensions and weights

Standard installation design

Dimensions					
Height	h	[mm]	325	325	325
Width	b	[mm]	140	140	140
Depth ²⁾	t	[mm]	199	199	199
Mass					
	m	[kg]	5.8	5.8	5.8

¹⁾ Technically possible cable lengths, irrespective of EMC requirements

²⁾ With safety engineering plus 20 mm

Inverter Drives 8400 HighLine

Technical data



Rated data 400 V

► Unless otherwise specified, the data refers to the default setting.

Data in left column per device

Operation with rated data: rated output current $I_{N,out}$ at mains voltage 400 V, switching frequency 8 kHz variable and max. ambient temperature 45 °C (default setting).
Output currents I_{out} apply to:
Ambient temperature 45 °C operating with constant switching frequency 2 kHz or 4 kHz.
Ambient temperature 40 °C operating with constant switching frequency 8 kHz or 16 kHz.

Data in right column per device

Operation with increased power: rated output current $I_{N,out}$ at mains voltage 400 V, switching frequency 4 kHz constant and max. ambient temperature 40 °C.
Output currents apply to:
Ambient temperature 40 °C operating with constant switching frequency 2 kHz or 4 kHz.

Typical motor power						
4-pole asynchronous motor	P	[kW]	18.5	22.0 ¹⁾	22.0 ¹⁾	30.0 ¹⁾
Product key			E84AVHC□1834□□0		E84AVHC□2234□□0	
Mains voltage range			3/PE AC 320 V-0 % ... 550 V+0 %, 45 Hz-0 % ... 65 Hz+0 %			
Rated mains current						
With mains choke	$I_{N,AC}$	[A]	36.0	42.2	42.0	50.8
Without mains choke	$I_{N,AC}$	[A]	50.4			
Rated output current						
	$I_{N,out}$	[A]	40.0	46.8	47.0	56.4
Output current						
2 kHz	I_{out}	[A]	40.0	46.8	47.0	56.4
4 kHz	I_{out}	[A]	40.0	46.8	47.0	56.4
8 kHz	I_{out}	[A]	40.0		47.0	
16 kHz	I_{out}	[A]	27.0		31.3	

Data for 60 s overload

Max. output current						
	$I_{max,out}$	[A]	60.0		70.5	
Overload time						
	t_{ol}	[s]		60.0		
Recovery time						
	t_{re}	[s]		120.0		

Data for 3 s overload

Max. short-time output current						
	$I_{max,out}$	[A]	78.0		89.3	
Overload time						
	t_{ol}	[s]		3.0		
Recovery time						
	t_{re}	[s]		12.0		

¹⁾ Operation only permitted with mains choke or mains filter

Inverter Drives 8400 HighLine

Technical data



Rated data 400 V

► Unless otherwise specified, the data refers to the default setting.

Typical motor power						
4-pole asynchronous motor	P	[kW]	18.5	22.0	22.0	30.0
Product key			E84AVHC□1834□□0		E84AVHC□2234□□0	
DC supply			DC 455 V -0 % ... 775 V +0 %			
Rated DC-bus current						
	$I_{N, DC}$	[A]	44.1			51.4
Power loss						
	P_V	[kW]	0.540			0.640
Max. cable length ¹⁾						
Shielded motor cable	I_{max}	[m]	100			

Brake chopper rated data

4.6

Rated power, Brake chopper				
	P_N	[kW]	35.0	35.0
Max. output power, Brake chopper				
	$P_{max, 1}$	[kW]	35.0	35.0
Min. brake resistance				
	R_{min}	[Ω]	15.0	15.0

Dimensions and weights

Standard installation design

Dimensions				
Height	h	[mm]	350	350
Width	b	[mm]	205	205
Depth ²⁾	t	[mm]	250	250
Mass				
	m	[kg]	12.0	12.0

¹⁾ Technically possible cable lengths, irrespective of EMC requirements

²⁾ With safety engineering plus 20 mm

Inverter Drives 8400 HighLine

Technical data



Rated data 400 V

► Unless otherwise specified, the data refers to the default setting.

Data in left column per device

Operation with rated data: rated output current $I_{N,out}$ at mains voltage 400 V, switching frequency 8 kHz variable and max. ambient temperature 45 °C (default setting).
Output currents I_{out} apply to:
Ambient temperature 45 °C operating with constant switching frequency 2 kHz or 4 kHz.
Ambient temperature 40 °C operating with constant switching frequency 8 kHz or 16 kHz.

Data in right column per device

Operation with increased power: rated output current $I_{N,out}$ at mains voltage 400 V, switching frequency 4 kHz constant and max. ambient temperature 40 °C.
Output currents apply to:
Ambient temperature 40 °C operating with constant switching frequency 2 kHz or 4 kHz.

								
Typical motor power								
4-pole asynchronous motor	P	[kW]	30.0 ¹⁾	37.0 ¹⁾	37.0 ¹⁾	45.0 ¹⁾	45.0 ¹⁾	55.0 ¹⁾
Product key			E84AVHC□3034□□□		E84AVHC□3734□□□		E84AVHC□4534□□□	
Mains voltage range			3/PE AC 320 V-0 % ... 550 V+0 %, 45 Hz-0 % ... 65 Hz+0 %					
Rated mains current								
With mains choke	$I_{N,AC}$	[A]	55.0	66.0	68.0	81.6	80.0	96.0
Without mains choke	$I_{N,AC}$	[A]						
Rated output current								
	$I_{N,out}$	[A]	61.0	73.2	76.0	91.2	89.0	106.8
Output current								
2 kHz	I_{out}	[A]	61.0	73.2	76.0	91.2	89.0	106.8
4 kHz	I_{out}	[A]	61.0	73.2	76.0	91.2	89.0	106.8
8 kHz	I_{out}	[A]	61.0		76.0		89.0	
16 kHz	I_{out}	[A]	41.0		51.0		60.0	

Data for 60 s overload

Max. output current					
	$I_{max,out}$	[A]	91.5	114.0	133.5
Overload time					
	t_{ol}	[s]		60.0	
Recovery time					
	t_{re}	[s]		120.0	

Data for 3 s overload

Max. short-time output current					
	$I_{max,out}$	[A]	112.1	136.8	169.1
Overload time					
	t_{ol}	[s]		3.0	
Recovery time					
	t_{re}	[s]		12.0	

¹⁾ Operation only permitted with mains choke or mains filter

Inverter Drives 8400 HighLine

Technical data



Rated data 400 V

► Unless otherwise specified, the data refers to the default setting.

							
Typical motor power							
4-pole asynchronous motor	P	[kW]	30.0	37.0	37.0	45.0	45.0
Product key			E84AVHC□3034□□□0		E84AVHC□3734□□□0		E84AVHC□4534□□□0
DC supply			DC 455 V -0 % ... 775 V +0 %				
	U _{DC}	[V]					
Rated DC-bus current							
	I _{N, DC}	[A]	67.4		83.3		98.0
Power loss							
	P _V	[kW]	0.840		0.980		1.300
Max. cable length ¹⁾							
Shielded motor cable	I _{max}	[m]	100				

Brake chopper rated data

4.6

Rated power, Brake chopper					
	P _N	[kW]	70.1	70.1	70.1
Max. output power, Brake chopper					
	P _{max, 1}	[kW]	70.1	70.1	70.1
Min. brake resistance					
	R _{min}	[Ω]	7.5	7.5	7.5

Dimensions and weights

Standard installation design

Dimensions					
Height	h	[mm]	450	450	450
Width	b	[mm]	250	250	250
Depth ²⁾	t	[mm]	250	250	250
Mass					
	m	[kg]	17.2	17.2	17.2

¹⁾ Technically possible cable lengths, irrespective of EMC requirements

²⁾ With safety engineering plus 20 mm



"Cold plate" design

Inverters in cold-plate design dissipate some of their waste heat (heat loss) via a cooler adapted to the application. For this purpose, the inverters are provided with a planed cooling plate which is connected to a separate cooler in a thermally conductive way. Using the cold plate technology, the main part of the heat energy can be transferred directly to the external cooling units.

The use of cold-plate technology is advantageous for the following application cases:

- Minimising the expense of cooling the control cabinet. Here, the main part of the power loss is directly transferred to a cooling unit outside of the control cabinet, e.g. convection cooler or water cooler.
- Heavily polluted ambient air or control cabinets with a high degree of protection which do not allow for a use of a forced air cooling of the control cabinets.
- Low mounting depth in the control cabinet.

Product key	Power to be dissipated	Thermal resistance
	P_V [W]	R_{th} [K/W]
E84AVHCC2512□□0	15.0	≤ 1.5
E84AVHCC3712□□0	20.0	≤ 1.5
E84AVHCC5512□□S	30.0	≤ 1.0
E84AVHCC7512□□S	40.0	≤ 1.0
E84AVHCC1122□□S	60.0	≤ 0.6
E84AVHCC1522□□S	75.0	≤ 0.5
E84AVHCC2222□□S	100	≤ 0.4
E84AVHCC3714□□S	25.0	≤ 1.0
E84AVHCC5514□□S	35.0	≤ 1.0
E84AVHCC7514□□S	50.0	≤ 1.0
E84AVHCC1124□□S	60.0	≤ 0.6
E84AVHCC1524□□S	70.0	≤ 0.5
E84AVHCC2224□□S	100	≤ 0.4
E84AVHCC3024□□S	100	≤ 0.4
E84AVHCC4024□□0	155	≤ 0.25
E84AVHCC5524□□0	215	≤ 0.18
E84AVHCC7524□□0	250	≤ 0.15
E84AVHCC1134□□0	355	≤ 0.11
E84AVHCC1534□□0	390	≤ 0.10
E84AVHCC1834□□0	460	≤ 0.057
E84AVHCC2234□□0	540	≤ 0.057
E84AVHCC3034□□0	720	≤ 0.053
E84AVHCC3734□□0	810	≤ 0.047
E84AVHCC4534□□0	1080	≤ 0.035

Dimensions and weights

Product key			E84AVHCC2512□□0	E84AVHCC3712□□0	E84AVHCC5512□□S	E84AVHCC7512□□S
Dimensions						
Height, including fastening	h	[mm]	186		236	
Width, including fastening	b	[mm]	102		70	
Depth	t	[mm]	185		163	
Mass						
	m	[kg]	1.3		1.5	

Product key			E84AVHCC1122□□S	E84AVHCC1522□□S	E84AVHCC2222□□S
Dimensions					
Height, including fastening	h	[mm]	295		
Width, including fastening	b	[mm]	70		
Depth	t	[mm]	163		
Mass					
	m	[kg]	2.0		

Inverter Drives 8400 HighLine

Technical data



"Cold plate" design

Dimensions and weights

Product key			E84AVHCC3714□□S	E84AVHCC5514□□S	E84AVHCC7514□□S
Dimensions					
Height, including fastening	h	[mm]		236	
Width, including fastening	b	[mm]		70	
Depth ¹⁾	t	[mm]		163	
Mass					
	m	[kg]		1.5	

Product key			E84AVHCC1124□□S	E84AVHCC1524□□S	E84AVHCC2224□□S
Dimensions					
Height, including fastening	h	[mm]		295	
Width, including fastening	b	[mm]		70	
Depth ¹⁾	t	[mm]		163	
Mass					
	m	[kg]		2.0	

Product key			E84AVHCC3024□□S	E84AVHCC4024□□0	E84AVHCC5524□□0	E84AVHCC7524□□0
Dimensions						
Height, including fastening	h	[mm]	295	318		378
Width, including fastening	b	[mm]	70		174	
Depth ¹⁾	t	[mm]	163		141	
Mass						
	m	[kg]	2.0	2.7		3.6

Product key			E84AVHCC1134□□0	E84AVHCC1534□□0	E84AVHCC1834□□0	E84AVHCC2234□□0
Dimensions						
Height, including fastening	h	[mm]		378		407
Width, including fastening	b	[mm]		174		231
Depth ¹⁾	t	[mm]		141		164
Mass						
	m	[kg]		3.6		9.3

Product key			E84AVHCC2234□□0	E84AVHCC3734□□0	E84AVHCC4534□□0
Dimensions					
Height, including fastening	h	[mm]	407		520
Width, including fastening	b	[mm]	231		250
Depth ¹⁾	t	[mm]	164		184
Mass					
	m	[kg]	9.3		16.9

¹⁾ With safety engineering plus 20 mm



Push-through technique design

The inverters in push-through design reduce the waste heat in the control cabinet.

The inverter is mounted in the control cabinet such that the heatsink of the inverter is outside the control cabinet. Thus, the entire waste heat can be dissipated outside the control cabinet via convection or forced air cooling for almost all device performances. For inverters with a power below 2.2 kW, restrictions may occur.

Using the push-through technology is advantageous in the following application cases:

- Minimising the expense for control cabinet cooling. For this purpose, the main part of the power loss is directly transferred to the ambience outside the control cabinet (e.g. convection cooling).
- In case of control cabinets with a high degree of protection > IP54 by using separate mounting and cooling areas.
- Low mounting depth in the control cabinet.

Inverter Drives 8400 HighLine

Technical data



Push-through technique design

Dimensions and weights

Product key			E84AVHCD2512□□□0	E84AVHCD3712□□□0	E84AVHCD5512□□□0	E84AVHCD7512□□□0
Dimensions						
Height, including fastening	h	[mm]	186		236	
Width, including fastening	b	[mm]	102			
Depth (in control cabinet) ¹⁾	t	[mm]	185		163	
Mass						
	m	[kg]	1.4		1.9	

Product key			E84AVHCD1122□□□0	E84AVHCD1522□□□0	E84AVHCD2222□□□0	E84AVHCD3714□□□0
Dimensions						
Height, including fastening	h	[mm]	295		236	
Width, including fastening	b	[mm]	137		102	
Depth (in control cabinet) ¹⁾	t	[mm]	163			
Mass						
	m	[kg]	3.5		1.9	

Product key			E84AVHCD5514□□□0	E84AVHCD7514□□□0	E84AVHCD1124□□□0	E84AVHCD1524□□□0
Dimensions						
Height, including fastening	h	[mm]	236		295	
Width, including fastening	b	[mm]	102		137	
Depth (in control cabinet) ¹⁾	t	[mm]	163			
Mass						
	m	[kg]	1.9		3.5	

Product key			E84AVHCD2224□□□0	E84AVHCD3024□□□0	E84AVHCD4024□□□0	E84AVHCD5524□□□0
Dimensions						
Height, including fastening	h	[mm]	295		318	
Width, including fastening	b	[mm]	137		174	
Depth (in control cabinet) ¹⁾	t	[mm]	163		141	
Mass						
	m	[kg]	3.5		4.9	

Product key			E84AVHCD7524□□□0	E84AVHCD1134□□□0	E84AVHCD1534□□□0
Dimensions					
Height, including fastening	h	[mm]	378		
Width, including fastening	b	[mm]	174		
Depth (in control cabinet) ¹⁾	t	[mm]	141		
Mass					
	m	[kg]	6.2		

¹⁾ With safety engineering plus 20 mm

Inverter Drives 8400 HighLine

Technical data





Mains connection

- ▶ The mains fuse and cable cross-section specifications are for a mains connection of 1 x 230V or 3 x 400V.
- ▶ Class gG/gI fuses or class gRL semiconductor fuses.
- ▶ The cable cross-sections apply to PVC-insulated copper cables.
- ▶ Use for installation with UL-approved cables, fuses and brackets.

Operation with mains choke

Typical motor power	Mains voltage	Product key	Circuit breaker	Fuse		Mains connection	
				EN 60204-1	UL		
4-pole asynchronous motor		Inverter				Cross-section (with mains choke)	
P	U _{AC}		I	I	I	q	
[kW]	[V]		[A]	[A]	[A]	[mm ²]	
0.25	1 AC 180 ... 264	E84AV□□□2512□□□	C6	6	6	1.0	
0.37		E84AV□□□3712□□□			10		
0.55		E84AV□□□5512□□□	C10	10	15	1.5	
0.75		E84AV□□□7512□□□			20		
1.10		E84AV□□□1122□□□	C16	16	25	2.5	
1.50		E84AV□□□1522□□□			30		
2.20		E84AV□□□2222□□□	C20	20	30	4.0	
0.37		3 AC 320 ... 550	E84AV□□□3714□□□	C6	6	6	1.0
0.55	E84AV□□□5514□□□		10				
0.75	E84AV□□□7514□□□						
1.10	E84AV□□□1124□□□					20	
1.50	E84AV□□□1524□□□		30				
2.20	E84AV□□□2224□□□						
3.00	E84AV□□□3024□□□			50			
4.00	E84AV□□□4024□□□		63				
5.50	E84AV□□□5524□□□				80		
7.50	E84AV□□□7524□□□			100			
11.0	E84AV□□□1134□□□		125				
15.0	E84AV□□□1534□□□				150		
18.5	E84AV□□□1834□□□			180			
22.0	E84AV□□□2234□□□		220				
30.0	E84AV□□□3034□□□				280		
37.0	E84AV□□□3734□□□			350			
45.0	E84AV□□□4534□□□		450				

4.6

Inverter Drives 8400 HighLine

Interfaces



Mains connection

Operation without mains choke

Typical motor power	Mains voltage	Product key	Circuit breaker	Fuse		Mains connection
				EN 60204-1	UL	
4-pole asynchronous motor		Inverter				Cross-section (without mains choke)
P	U_{AC}		I	I	I	q
[kW]	[V]		[A]	[A]	[A]	[mm ²]
0.25	1 AC 180... 264	E84AV□□□2512□□□	C6	6	6	1.0
0.37		E84AV□□□3712□□□			10	
0.55		E84AV□□□5512□□□	C10	10	15	1.5
0.75		E84AV□□□7512□□□			20	
1.10		E84AV□□□1122□□□	C16	16	25	2.5
1.50		E84AV□□□1522□□□			30	
2.20		E84AV□□□2222□□□	C25	25	30	6.0
0.37	3 AC 320... 550	E84AV□□□3714□□□	C6	6	6	1.0
0.55		E84AV□□□5514□□□				
0.75		E84AV□□□7514□□□				
1.10		E84AV□□□1124□□□	C10	10	10	1.5
1.50		E84AV□□□1524□□□				
2.20		E84AV□□□2224□□□	C16	16	15	2.5
3.00		E84AV□□□3024□□□			20	
4.00		E84AV□□□4024□□□	C25	25	25	4.0
5.50		E84AV□□□5524□□□			40	
7.50		E84AV□□□7524□□□	C32	32	40	10.0
11.0		E84AV□□□1134□□□			60	
18.5		E84AV□□□1834□□□	C80	80	60	25.0

4.6



Motor connection

- ▶ Keep motor cables as short as possible, as this has a positive effect on the drive behaviour.
- ▶ With group drives (multiple motors on one inverter), the resulting cable length is the key factor. This can be calculated using the hardware manual.
- ▶ Electric strength of the motor cable: 1 kV as per VDE 250-1.
- ▶ Capacitance per unit length
 - ≤ 1.5 mm² / AWG 16: C_{core-core} / C_{core-shield} ≤ 75 / ≤ 150 pF/m
 - ≥ 2.5 mm² / AWG 12: C_{core-core} / C_{core-shield} ≤ 100 / ≤ 150 pF/m.

Maximum shielded motor cable length without EMC limit values at switching frequency

Rated mains voltage	Typical motor power	Product key Inverter	4 kHz (without limit value)		8 kHz (without limit value)	16 kHz (without limit value)
			45 °C	40 °C	40 °C	40 °C
U _{in} [V]	P [kW]		I _{max} [m]	I _{max} [m]	I _{max} [m]	I _{max} [m]
230	0.25	E84AV□□□2512□□□				50
	0.37	E84AV□□□3712□□□				
	0.55	E84AV□□□5512□□□				
	0.75	E84AV□□□7512□□□				
	1.10	E84AV□□□1122□□□				
	1.50	E84AV□□□1522□□□				
	2.20	E84AV□□□2222□□□				
400	0.37	E84AV□□□3714□□□	50	100	50	25
	0.55	E84AV□□□5514□□□				
	0.75	E84AV□□□7514□□□				
	1.10	E84AV□□□1124□□□				
	1.50	E84AV□□□1524□□□				
	2.20	E84AV□□□2224□□□				
	3.00	E84AV□□□3024□□□				
	4.00	E84AV□□□4024□□□	100	150	100	100
	5.50	E84AV□□□5524□□□				
	7.50	E84AV□□□7524□□□				
	11.0	E84AV□□□1134□□□				
	15.0	E84AV□□□1534□□□				
	18.5	E84AV□□□1834□□□				
	22.0	E84AV□□□2234□□□				
	30.0	E84AV□□□3034□□□				
37.0	E84AV□□□3734□□□					
45.0	E84AV□□□4534□□□					
500	0.37	E84AV□□□3714□□□	50	100	25	15
	0.55	E84AV□□□5514□□□				
	0.75	E84AV□□□7514□□□				
	1.10	E84AV□□□1124□□□				
	1.50	E84AV□□□1524□□□				
	2.20	E84AV□□□2224□□□				
	3.00	E84AV□□□3024□□□				



Motor connection

Maximum shielded motor cable length without EMC limit values at switching frequency

Rated mains voltage	Typical motor power	Product key	4 kHz (without limit value)		8 kHz (without limit value)	16 kHz (without limit value)
			45 °C	40 °C	40 °C	40 °C
U_{in}	P	Inverter	I_{max}	I_{max}	I_{max}	I_{max}
[V]	[kW]		[m]	[m]	[m]	[m]
500	4.00	E84AV□□□4024□□□	50	100	50	50
	5.50	E84AV□□□5524□□□				
	7.50	E84AV□□□7524□□□				
	11.0	E84AV□□□1134□□□	100	150	100	100
	15.0	E84AV□□□1534□□□				
	18.5	E84AV□□□1834□□□				
	22.0	E84AV□□□2234□□□				
	30.0	E84AV□□□3034□□□				
	37.0	E84AV□□□3734□□□				
45.0	E84AV□□□4534□□□					

4.6

Maximum shielded motor cable length acc. to category C2 (industry), conducted

- The values for I_{max} are valid for an ambient temperature of up to 40°C.

Rated mains voltage	Typical motor power	Product key	Integrated filter		RFI filter SD		RFI filter LD	
			4 kHz	8 kHz	4 kHz	8 kHz	4 kHz	8 kHz
U_{in}	P	Inverter	I_{max}	I_{max}	I_{max}	I_{max}	I_{max}	I_{max}
[V]	[kW]		[m]	[m]	[m]	[m]	[m]	[m]
230	0.25	E84AV□□□2512□□□	25	25	50	50	100	50
	0.37	E84AV□□□3712□□□						
	0.55	E84AV□□□5512□□□						
	0.75	E84AV□□□7512□□□						
	1.10	E84AV□□□1122□□□						
	1.50	E84AV□□□1522□□□						
	2.20	E84AV□□□2222□□□						
400	0.37	E84AV□□□3714□□□						
	0.55	E84AV□□□5514□□□						
	0.75	E84AV□□□7514□□□						
	1.10	E84AV□□□1124□□□						
	1.50	E84AV□□□1524□□□						
	2.20	E84AV□□□2224□□□						
	3.00	E84AV□□□3024□□□						
	4.00	E84AV□□□4024□□□						
	5.50	E84AV□□□5524□□□						
	7.50	E84AV□□□7524□□□						
11.0	E84AV□□□1134□□□							
15.0	E84AV□□□1534□□□							

Inverter Drives 8400 HighLine

Interfaces



Motor connection

Maximum shielded motor cable length acc. to category C2 (industry), conducted

- The values for I_{max} are valid for an ambient temperature of up to 40°C.

Rated mains voltage	Typical motor power	Product key	Integrated filter		RFI filter SD		RFI filter LD	
			4 kHz	8 kHz	4 kHz	8 kHz	4 kHz	8 kHz
U_{in}	P	Inverter	I_{max}	I_{max}	I_{max}	I_{max}	I_{max}	I_{max}
[V]	[kW]		[m]	[m]	[m]	[m]	[m]	[m]
400	18.5	E84AV□□□1834□□□	25	25	50	25	100	100
	22.0	E84AV□□□2234□□□						
	30.0	E84AV□□□3034□□□						
	37.0	E84AV□□□3734□□□						
	45.0	E84AV□□□4534□□□						
500	0.37	E84AV□□□3714□□□	25	25	50	50	100	100
	0.55	E84AV□□□5514□□□						
	0.75	E84AV□□□7514□□□						
	1.10	E84AV□□□1124□□□						
	1.50	E84AV□□□1524□□□						
	2.20	E84AV□□□2224□□□						
	3.00	E84AV□□□3024□□□						
	4.00	E84AV□□□4024□□□						
	5.50	E84AV□□□5524□□□						
	7.50	E84AV□□□7524□□□						
	11.0	E84AV□□□1134□□□						
	15.0	E84AV□□□1534□□□						
	18.5	E84AV□□□1834□□□						
	22.0	E84AV□□□2234□□□						
	30.0	E84AV□□□3034□□□						
37.0	E84AV□□□3734□□□							
45.0	E84AV□□□4534□□□							

4.6



Motor connection

Operation with earth-leakage circuit breaker

If the inverter is connected via an earth-leakage circuit breaker, the following cable lengths are permissible, although the table must also be taken into account:

Earth-leakage circuit breaker 30 mA:

- 0.25 ... 2.2 kW to 25 m shielded motor cable with integrated RFI measures
- 0.25 ... 15 kW to 25 m shielded motor cable with RFI filter SD.

Earth-leakage circuit breaker 300 mA:

- 0.25 to 45 kW up to 25 m shielded motor cable with integrated RFI measures
- 0.25 to 45 kW up to 50 m shielded motor cable with RFI filter LD.

- ▶ When RFI filters SD are used, C1 can be complied with in a conducted manner (a shielded motor cable up to 25 m).
- ▶ In case of 0.25 ... 2.2 kW (230 V) with RFI filter LL, C1 and a fault current <3.5 mA can be realised (a shielded motor cable of up to 5 m).



Connection diagrams

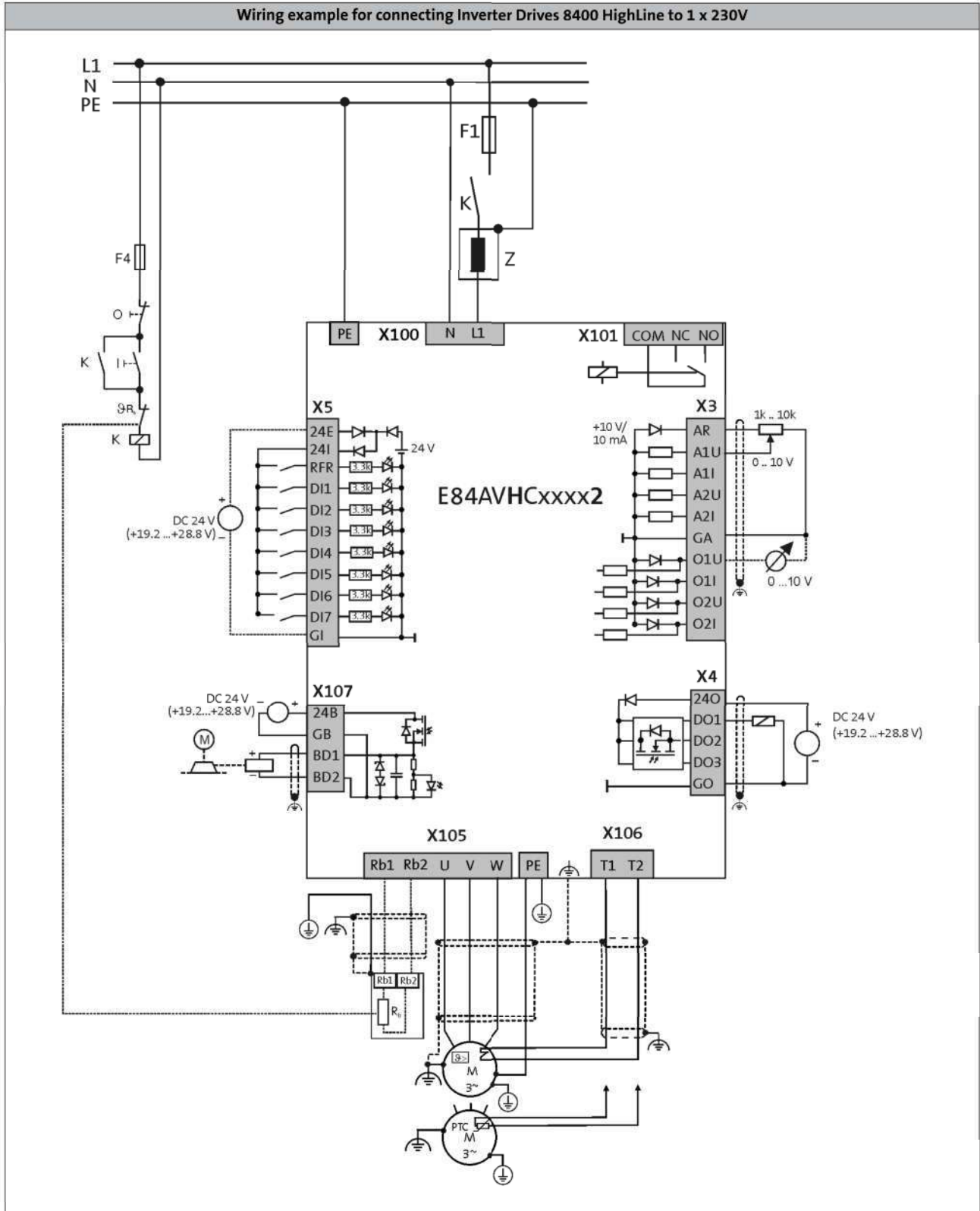



Connection diagrams

Wiring example for connecting Inverter Drives 8400 HighLine to 3 x 400V

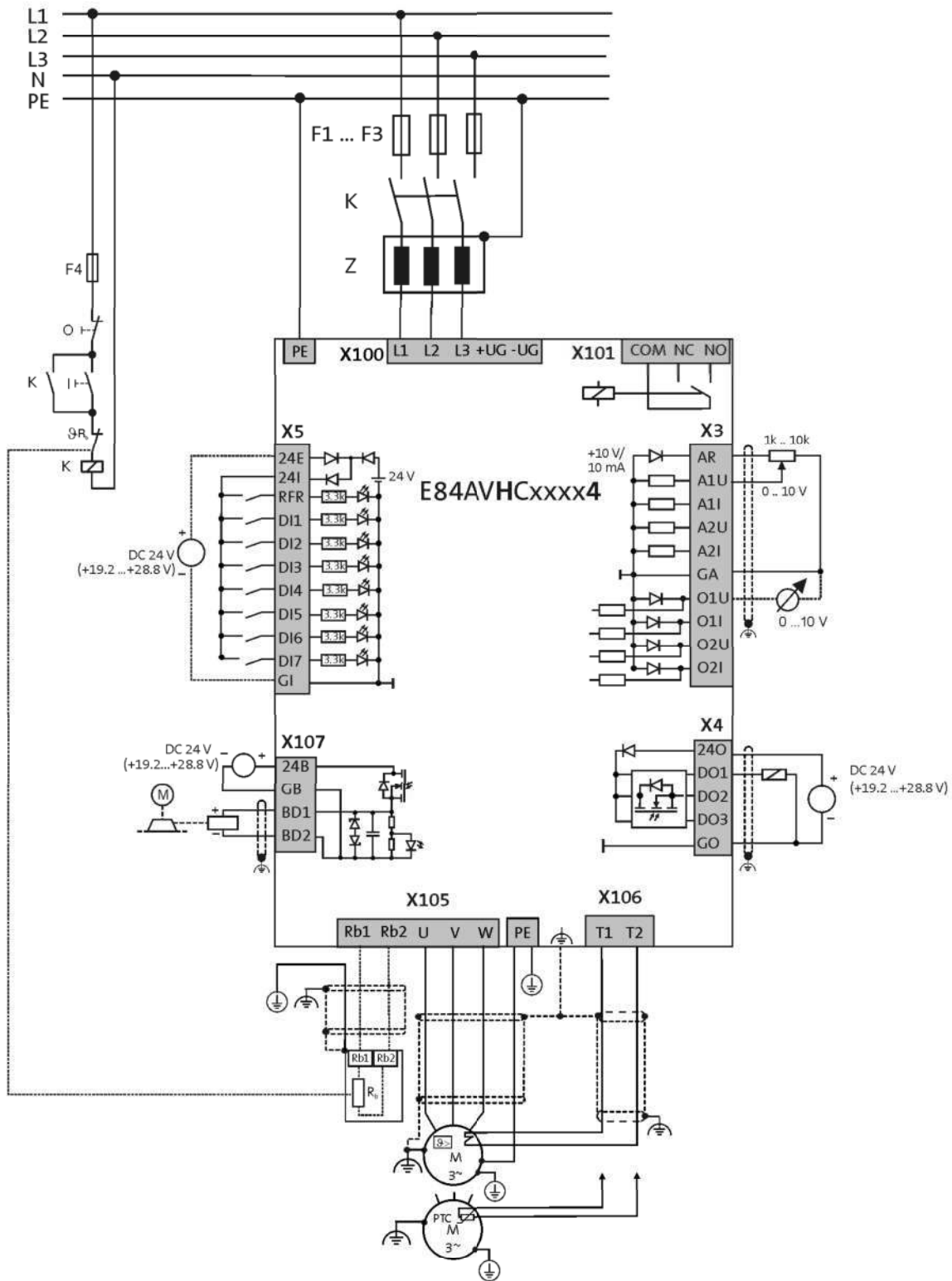

4.6



Control connections

Mode	8400 HighLine
Analog inputs	
Number	2 Optional: voltage or current input
Resolution	10 bits + sign
Value range	0 ... +/- 10V, 0/4 ... 20 mA
Analog outputs	
Number	2 Optional: voltage or current output
Resolution	10 bits
Value range	0 ... 10V, 0/4 ... 20mA
Digital inputs	
Number	8
Switching level	PLC (IEC 61131-2)
Max. input current	11 mA
Function	2 inputs, can optionally be used as a frequency input (200 kHz, 2-track) 2 inputs, can optionally be used as a frequency input (10 kHz, 2-track)
Digital outputs	
Number	4
Switching level	PLC (IEC 61131-2)
Max. output current	1 x 2.5A, (basic insulation, with spark suppressor, e.g. for 24 V service brake) 3 x 50mA
Relay	
Number	1
Contact	Changeover contact
AC connection	250V, 3A
DC connection	24V, 2A ... 240V, 0.16A
External DC supply	
Rated voltage	24 V
Interfaces	
CANopen	Integrated functional insulated Max. baud rate 1000 kbps DIP switch for address, baud rate, bus termination
Extensions	optional communication module
Safety engineering	Optional Safe torque off (STO)
Drive interface	
Encoder input	Via 2 digital inputs: HTL, 2-track, 200 kHz Via 2/4 digital inputs: HTL, 2/4-track, 5 kHz

¹⁾ For mains-independent control electronics supply



Control connections

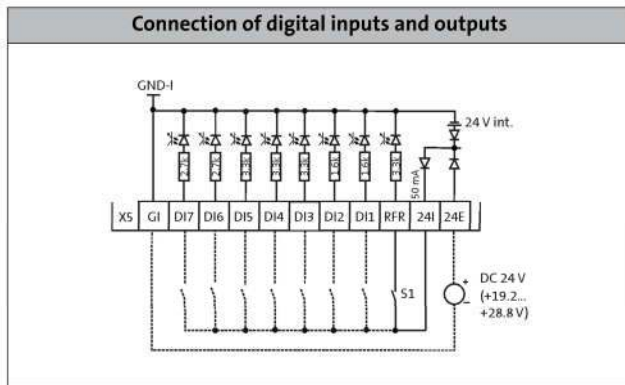
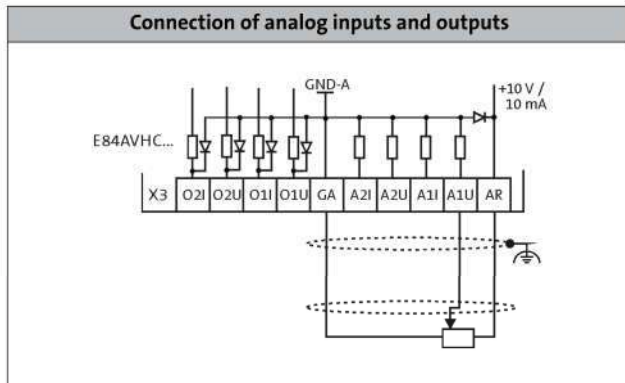

4.6

Inverter Drives 8400 HighLine

Interfaces



Memory module

All drive settings for the 8400 are stored on the memory module, which is a pluggable memory chip. The memory module ensures that drives can be replaced quickly and without errors being made.

Mode	Features	Product key
Memory module	<ul style="list-style-type: none">• For 8400 StateLine, HighLine, Topline and protec• Packaging unit: 5 items	E84AYM10S/M

- Each inverter is equipped with a memory module in the factory

Safety system (STO)

The 8400 StateLine, HighLine and TopLine models are optionally available with "STO safe torque off" safety engineering. This helps reduce control system costs, save space in the control cabinet and keep wiring to a minimum. The safety engineering is certified to EN ISO 13849-1 (Cat. 4, PL e), EN 61508/EN 62061 (SIL 3).

The inverters can optionally be ordered with integrated safety engineering (STO). In this case, the product key of the inverter has a "B" as the 14th character.

For example, a StateLine 230 V, 0.55 kW built-in unit with safety engineering would be: E84AVSCE5512SB0



8400 StateLine with safety engineering

4.6

Inverter Drives 8400 HighLine

Interfaces



EtherCAT® communication module

A communication module is used to connect the 8400 StateLine, HighLine or TopLine to a bus system.



EtherCAT® communication module

Mode		Features	Slot	Product key
Communication module				
EtherCAT		<ul style="list-style-type: none"> • Distributed clock • 5 LEDs for status display • 2 RJ45 connections with LEDs for link and activity • Connection option for separate 24 V supply 	MCI	E84AYCETV/S

4.6

- ▶ The Inverter Drives 8400 can be ordered with a plug-in EtherCAT® communication module already installed. If you would like to order the products in this complete form, please add the inverter product key as follows when placing your order: E84AV to X-ETXXX
- ▶ The product key with the supplement for the applied module is provided in our sales documents. This information is not part of the nameplate of the device.

Standards and operating conditions

Product key				E84AYCETV/S
Mode				EtherCAT
Degree of protection				IP20
Climatic conditions				
Storage (EN 60721-3-1)				1K3 (temperature: -25 °C ... +60 °C)
Transport (EN 60721-3-2)				2K3 (temperature: -25 °C ... +70 °C)
Operation (EN 60721-3-3)				3K3 (temperature: -10°C ... +55 °C)
Insulation voltage to reference earth/PE				
EN 61800-5-1	U_{AC}	[V]		50.0



EtherCAT® communication module

Rated data

Product key			E84AVCETV/S
Communication			
Medium			CAT5e S/FTP according to ISO/ICE11801 (2002)
Communication profile			CoE (CANopen over EtherCAT)
Baud rate			
	b	[MBit/s]	100
Node			
			Slave
Network topology			
			Line
Number of logical process data channels			
			1
Process data words (PCD)			
16 Bit			1 ... 16
Number of bus nodes			
			Max. 65535
Max. cable length			
between two nodes	l_{\max}	[m]	100

Inverter Drives 8400 HighLine

Interfaces



EtherNet/IP communication module

A communication module is used to connect the 8400 StateLine, HighLine or TopLine to a bus system.



EtherNet/IP communication module

Mode		Features	Slot	Product key
Communication module				
EtherNet/IP		<ul style="list-style-type: none"> • 5 LEDs for status display • 2 RJ45 connections with LEDs for link and activity • Address can be set via 2 rotary DIP switches • TCP/IP channel • ODVA certification (Open Device Vendor Association) • Supported assembly object instances as per ODVA: 20, 21, 22, 23 and 70, 71, 72, 73 • Manufacturer-specific supported assembly object instances (custom): 110 and 111 • Connection option for separate 24 V supply 	MCI	E84AYCEOV/S

4.6

- ▶ The Inverter Drives 8400 can be ordered with a plug-on PROFINET communication module already installed. If you would like to order the products in this complete form, please add the inverter product key as follows when placing your order: E84AV to X-EOXXX
- ▶ The product key with the supplement for the applied module is provided in our sales documents. This information is not part of the nameplate of the device.

Standards and operating conditions

Product key				E84AYCEOV/S
Mode				EtherNet/IP
Degree of protection				IP20
EN 60529				
Climatic conditions				
Storage (EN 60721-3-1)				1K3 (temperature: -25 °C ... +60 °C)
Transport (EN 60721-3-2)				2K3 (temperature: -25 °C ... +70 °C)
Operation (EN 60721-3-3)				3K3 (temperature: -10°C ... +55 °C)
Insulation voltage to reference earth/PE				
EN 61800-5-1	U _{AC}	[V]		50.0



EtherNet/IP communication module

Rated data

Product key			E84AYCEOV/S
Communication			
Medium			CAT5e S/FTP according to ISO/ICE11801 / EN50173
Communication profile			EtherNET/IP, AC Drive
Baud rate			
	b	[MBit/s]	10/100 (full duplex/half duplex)
Node			
			Slave (Adapter)
Network topology			
			Tree, star and line
Process data words (PCD)			
16 Bit			1 ... 16
Number of bus nodes			
			max. 254 im Subnetz
Max. cable length			
between two nodes	l_{\max}	[m]	100

Inverter Drives 8400 HighLine

Interfaces



Ethernet POWERLINK communication module

A communication module is used to connect the 8400 StateLine, HighLine or TopLine to a bus system.



POWERLINK communication module

Mode		Features	Slot	Product key
Communication module				
Ethernet POWERLINK CN		<ul style="list-style-type: none"> • Sync mode, Multiplex mode • 5 LEDs for status display • 2 x RJ45 connections with LEDs for link and collision • Address can be set via 2 rotary DIP switches • Connection option for separate 24 V supply 	MCI	E84AYCECV/S

4.6

- ▶ The Inverter Drives 8400 can be ordered with a plug-in POWERLINK communication module already installed. If you would like to order the products in this complete form, please add the inverter product key as follows when placing your order: E84AV to X-ECXXX
- ▶ The product key with the supplement for the applied module is provided in our sales documents. This information is not part of the nameplate of the device.

Standards and operating conditions

Product key				E84AYCECV/S
Mode				Ethernet POWERLINK CN
Degree of protection				IP20
EN 60529				
Climatic conditions				
Storage (EN 60721-3-1)				1K3 (temperature: -25 °C ... +60 °C)
Transport (EN 60721-3-2)				2K3 (temperature: -25 °C ... +70 °C)
Operation (EN 60721-3-3)				3K3 (temperature: -10°C ... +55 °C)
Insulation voltage to reference earth/PE				
EN 61800-5-1	U_{AC}		[V]	50.0

Inverter Drives 8400 HighLine

Interfaces



Ethernet POWERLINK communication module

Rated data

Product key			E84AYCECV/S
Communication			
Medium			CAT5e S/FTP according to ISO/ICE11801 (2002)
Communication profile			EPL2.0
Baud rate			
	b	[MBit/s]	100
Node			
			Controlled node (CN)
Network topology			
			Tree, star and line
Number of logical process data channels			
			1
Process data words (PCD)			
16 Bit			1 ... 16
Number of bus nodes			
			max. 239
Max. cable length			
between two nodes	l_{max}	[m]	100

Inverter Drives 8400 HighLine

Interfaces



PROFIBUS communication module

A communication module is used to connect the 8400 StateLine, HighLine or TopLine to a bus system.



PROFIBUS communication module

Mode		Features	Slot	Product key
Communication module				
PROFIBUS		<ul style="list-style-type: none"> • 5 LEDs for status display • Sub-D connection • Address can be set via DIP switch 	MCI	E84AYCPMV/S

4.6

- ▶ The Inverter Drives 8400 can be ordered with a plug-in PROFIBUS communication module already installed. If you would like to order the products in this complete form, please add the inverter product key as follows when placing your order: E84AV to X-PMXXX
- ▶ The product key with the supplement for the applied module is provided in our sales documents. This information is not part of the nameplate of the device.

Standards and operating conditions

Product key				E84AYCPMV/S
Mode				PROFIBUS
Degree of protection				IP20
Climatic conditions				
Storage (EN 60721-3-1)				1K3 (temperature: -25 °C ... +60 °C)
Transport (EN 60721-3-2)				2K3 (temperature: -25 °C ... +70 °C)
Operation (EN 60721-3-3)				3K3 (temperature: -10°C ... +55 °C)
Insulation voltage to reference earth/PE				
EN 61800-5-1	U _{AC}	[V]		50.0



PROFIBUS communication module

Rated data

Product key			E84AYCPMV/S
Communication			
Medium			RS 485
Communication profile			PROFIBUS-DP-V1 PROFIBUS-DP-V0
Device profile			PROFIDrive, version 3
Baud rate			
	b	[kBit/s]	9.6 ... 12 000 (automatic detection)
Node			Slave
Network topology			Line with repeater: Line or tree without repeater:
Process data words (PCD)			
16 Bit			1 ... 16
DP user data length			Optional parameter channel (4 words) + process data words
Number of bus nodes			31 slaves + 1 master per bus segment With repeaters: 125
Max. cable length			
per bus segment	l_{\max}	[m]	1200 (depending on the baud rate and the cable type used)

Inverter Drives 8400 HighLine

Interfaces



PROFINET communication module

A communication module is used to connect the 8400 StateLine, HighLine or TopLine to a bus system.



PROFINET communication module

Mode		Features	Slot	Product key
Communication module				
PROFINET		<ul style="list-style-type: none"> • 5 LEDs for status display • 2 RJ45 connections with LEDs for link and activity • TCP/IP channel • Connection option for separate 24 V supply 	MCI	E84AYCERV/S

4.6

- ▶ The Inverter Drives 8400 can be ordered with a plug-on PROFINET communication module already installed. If you would like to order the products in this complete form, please add the inverter product key as follows when placing your order: E84AV to X-ER-XXX
- ▶ The product key with the supplement for the applied module is provided in our sales documents. This information is not part of the nameplate of the device.

Standards and operating conditions

Product key				E84AYCERV/S
Mode				PROFINET
Degree of protection				IP20
Climatic conditions				
Storage (EN 60721-3-1)				1K3 (temperature: -25 °C ... +60 °C)
Transport (EN 60721-3-2)				2K3 (temperature: -25 °C ... +70 °C)
Operation (EN 60721-3-3)				3K3 (temperature: -10°C ... +55 °C)
Insulation voltage to reference earth/PE				
EN 61800-5-1	U_{AC}	[V]		50.0

Inverter Drives 8400 HighLine

Interfaces



PROFINET communication module

Rated data

Product key			E84AVCERV/S
Communication			
Medium			CAT5e S/FTP according to ISO/ICE11801 (2002)
Communication profile			PROFINET RT Conf. Class B
Baud rate			
	b	[MBit/s]	100
Node			
			Slave (Device)
Network topology			
			Line
Number of logical process data channels			
			1
Process data words (PCD)			
16 Bit			1 ... 16
Max. cable length			
between two nodes	l_{\max}	[m]	100

Inverter Drives 8400 HighLine

Interfaces





Brake resistors

An external brake resistor is required to brake high moments of inertia or in the event of prolonged operation in generator mode; this resistor converts braking energy into heat.

The brake resistors recommended in the table below have been dimensioned for approx. 1.5 times the regenerative power, with a cycle time of 15/135 s (brake/rest ratio). These brake resistors generally meet the usual requirements of standard applications.

The brake resistors are fitted with a thermostat (potential-free NC contact).



ERBM...(IP50) brake resistor

Typical motor power	Mains voltage	Product key		Rated resistance	Rated power	Thermal capacity	Dimensions	Mass
		Inverter	Brake resistor					
4-pole asynchronous motor								
P	U _{AC}			R _N	P _N	C _{th}	h x b x t	m
[kW]	[V]			[Ω]	[kW]	[KWs]	[mm]	[kg]
0.25	1 AC 180 ... 264	E84AV□□□2512□□□	ERBM180R050W	180.0	0.050	7.50	175 x 20.6 x 40	0.3
0.37		E84AV□□□3712□□□						
0.55		E84AV□□□5512□□□	ERBM100R100W	100.0	0.10	15.0	240 x 80 x 95	0.5
0.75		E84AV□□□7512□□□						
1.10		E84AV□□□1122□□□	ERBP033R200W	33.0	0.20	30.0	240 x 41 x 122	1.0
1.50		E84AV□□□1522□□□						
2.20		E84AV□□□2222□□□	ERBP033R300W		0.30	45.0	320 x 41 x 122	1.4
0.37	3 AC 320 ... 550	E84AV□□□3714□□□	ERBM390R100W	390.0	0.10	15.0	235 x 20.6 x 40	0.4
0.55		E84AV□□□5514□□□						
0.75		E84AV□□□7514□□□	ERBP180R200W	180.0	0.20	30.0	240 x 41 x 122	1.0
1.10		E84AV□□□1124□□□						
1.50		E84AV□□□1524□□□	ERBP180R300W		0.30	45.0	320 x 41 x 122	1.4
2.20		E84AV□□□2224□□□						



Brake resistors

For standard applications, we recommend the following combinations:

- E84AV□□□3024□□□ and ERBP082R200W
- E84AV□□□4024□□□ and ERBS047R400W
- E84AV□□□5524□□□ and ERBS047R800W
- E84AV□□□7524□□□ and ERBS027R01K2
- E84AV□□□1134□□□ and ERBS027R01K2
- E84AV□□□1534□□□ and ERBS018R01K4
- E84AV□□□1834□□□ and ERBS015R02K4
- E84AV□□□2234□□□ and ERBS015R02K4.



Other possible combinations:

ERBP...(IP21) and ERBS...(IP65) brake resistor

Typical motor power	Mains voltage	Product key		Rated resistance	Rated power	Thermal capacity	Dimensions	Mass
		Inverter	Brake resistor					
P	U _{AC}			R _N	P _N	C _{th}	h x b x t	m
[kW]	[V]			[Ω]	[kW]	[KWs]	[mm]	[kg]
3.00	3 AC 320 ... 550	E84AV□□□3024□□□	ERBP082R200W	82.0	0.20	30.0	320 x 41 x 122	1.0
			ERBS082R780W		0.78	117	666 x 124 x 122	4.0
4.00		E84AV□□□4024□□□	ERBS047R400W	47.0	0.40	60.0	400 x 110 x 105	2.3
			ERBS047R800W		0.80	120	710 x 110 x 105	3.9
5.50		E84AV□□□5524□□□	ERBS047R400W		0.40	60.0	400 x 110 x 105	2.3
			ERBS047R800W		0.80	120	710 x 110 x 105	3.9
7.50		E84AV□□□7524□□□	ERBP027R200W	27.0	0.20	30.0	320 x 41 x 122	1.0
			ERBS027R600W		0.60	90.0	550 x 110 x 105	3.1
			ERBS027R01K2		1.20	180	1020 x 110 x 105	5.6
11.0		E84AV□□□1134□□□	ERBP027R200W		0.20	30.0	320 x 41 x 122	1.0
			ERBS027R600W		0.60	90.0	550 x 110 x 105	3.1
			ERBS027R01K2		1.20	180	1020 x 110 x 105	5.6
15.0		E84AV□□□1534□□□	ERBS018R800W	18.0	0.80	120	710 x 110 x 105	3.9
			ERBS018R01K4		1.40	210	1110 x 110 x 105	6.2
	ERBS018R02K8		2.80		420	1110 x 200 x 105	12.0	
18.5	E84AV□□□1834□□□	ERBS015R800W	15.0	0.80	120	710 x 110 x 105	3.9	
		ERBS015R01K2		1.20	180	1020 x 110 x 105	5.6	
		ERBS015R02K4		2.40	420	1020 x 200 x 105	10.0	
22.0	E84AV□□□2234□□□	ERBS015R800W		0.80	120	710 x 110 x 105	3.9	
		ERBS015R01K2		1.20	180	1020 x 110 x 105	5.6	
		ERBS015R02K4		2.40	420	1020 x 200 x 105	10.0	
30.0	E84AV□□□3034□□□	ERBG075D01K9	7.5	1.90	285	486 x 236 x 302	9.5	
37.0	E84AV□□□3734□□□							
45.0	E84AV□□□4534□□□							

Inverter Drives 8400 HighLine

Accessories



Mains chokes

A mains choke is an inductive resistor which is connected in the mains cable of the power supply module. The use of a mains choke provides the following advantages:

- **Fewer effects on the mains:**
The wave form of the mains current is a close approximation to a sine wave.
- **Reduction in the effective mains current:**
Reduction of mains, cable and fuse loads

Mains chokes can be used without restrictions in conjunction with RFI filters and/or sinusoidal filters.

Please note:

: The use of a mains choke slightly reduces the mains voltage at the input of the inverter - the typical voltage drop across the mains choke at the rated values is around 4%.



Mains choke

Operation at rated power

Typical motor power	Mains voltage	Product key		Rated current	Dimensions	Mass
		Inverter	Mains choke			
4-pole asynchronous motor						
P	U _{AC}			I _N	h x b x t	m
[kW]	[V]			[A]	[mm]	[kg]
0.25	1 AC 180 ... 264	E84AV□□□2512□□□□	ELN1-0900H005	5.00	75 x 66 x 82	1.1
0.37		E84AV□□□3712□□□□				
0.55		E84AV□□□5512□□□□	ELN1-0500H009	9.00		
0.75		E84AV□□□7512□□□□				
1.10		E84AV□□□1122□□□□	ELN1-0250H018	18.0		
1.50		E84AV□□□1522□□□□				
2.20		E84AV□□□2222□□□□				
0.37	3 AC 320 ... 550	E84AV□□□3714□□□□	EZAELN3002B153	2.00	56 x 77 x 100	0.5
0.55		E84AV□□□5514□□□□	EZAELN3004B742	4.00	60 x 95 x 115	1.3
0.75		E84AV□□□7514□□□□				
1.10		E84AV□□□1124□□□□	EZAELN3006B492	6.00	69 x 95 x 120	1.5
1.50		E84AV□□□1524□□□□				
2.20		E84AV□□□2224□□□□				
3.00		E84AV□□□3024□□□□	EZAELN3008B372	8.00	85 x 120 x 140	1.9
4.00		E84AV□□□4024□□□□	EZAELN3010B292	10.0		2.0
5.50		E84AV□□□5524□□□□	EZAELN3016B182	16.0	95 x 120 x 140	2.7
7.50		E84AV□□□7524□□□□	EZAELN3020B152	20.0	95 x 155 x 165	3.8
11.0		E84AV□□□1134□□□□	EZAELN3025B122	25.0	110 x 155 x 170	5.8
15.0		E84AV□□□1534□□□ ¹⁾	EZAELN3035B841	35.0		6.0
18.5		E84AV□□□1834□□□□	EZAELN3045B651	45.0	112 x 185 x 200	8.3
22.0		E84AV□□□2234□□□ ¹⁾	EZAELN3050B591	50.0	112 x 185 x 210	8.4
30.0		E84AV□□□3034□□□ ¹⁾	EZAELN3063B471	63.0	122 x 185 x 210	9.7
37.0	E84AV□□□3734□□□ ¹⁾	EZAELN3080B371	80.0	125 x 210 x 240	12.5	
45.0	E84AV□□□4534□□□ ¹⁾	EZAELN3090B331	90.0	115 x 267 x 205	11.5	

¹⁾ Operation only permitted with mains choke

- On some inverters, a mains filter (combination of RFI filter and mains choke) can be used in place of a mains choke. Information on this can be found in the "Interference suppression" section.

Inverter Drives 8400 HighLine

Accessories



Mains chokes

Operation with increased power output



Mains choke

Typical motor power	Mains voltage	Product key		Rated current	Dimensions	Mass
		Inverter	Mains choke			
4-pole asynchronous motor						
P	U_{AC}			I_N	h x b x t	m
[kW]	[V]			[A]	[mm]	[kg]
0.37	1 AC 180 ... 264	E84AV□□□2512□□□	ELN1-0900H005	5.00	75 x 66 x 82	1.1
0.55		E84AV□□□3712□□□ ¹⁾				
0.75		E84AV□□□5512□□□	ELN1-0500H009	9.00		
1.10		E84AV□□□7512□□□ ¹⁾				
1.50		E84AV□□□1122□□□	ELN1-0250H018	18.0		
2.20		E84AV□□□1522□□□ ¹⁾				
0.55	3 AC 320 ... 550	E84AV□□□3714□□□	EZAELN3002B153	2.00	56 x 77 x 100	0.5
0.75		E84AV□□□5514□□□	EZAELN3004B742	4.00	60 x 95 x 115	1.3
1.10		E84AV□□□7514□□□ ¹⁾				
1.50		E84AV□□□1124□□□	EZAELN3006B492	6.00	69 x 95 x 120	1.5
2.20		E84AV□□□1524□□□				
3.00		E84AV□□□2224□□□ ¹⁾	EZAELN3008B372	8.00	85 x 120 x 140	1.9
4.00		E84AV□□□3024□□□ ¹⁾	EZAELN3010B292	10.0		
5.50		E84AV□□□3024□□□				
7.50		E84AV□□□4024□□□	EZAELN3016B182	16.0	95 x 120 x 140	2.7
11.0		E84AV□□□5524□□□ ¹⁾	EZAELN3020B152	20.0	95 x 155 x 165	3.8
15.0		E84AV□□□7524□□□	EZAELN3025B122	25.0	110 x 155 x 170	5.8
22.0		E84AV□□□1134□□□ ¹⁾	EZAELN3030B982	30.0	110 x 155 x 167	5.9
30.0		E84AV□□□1834□□□ ¹⁾	EZAELN3045B651	45.0	112 x 185 x 200	8.3
37.0		E84AV□□□2234□□□ ¹⁾	EZAELN3063B471	63.0	122 x 185 x 210	9.7
45.0		E84AV□□□3034□□□ ¹⁾	EZAELN3080B371	80.0	125 x 210 x 240	12.5
55.0		E84AV□□□3734□□□ ¹⁾	EZAELN3090B331	90.0	115 x 267 x 205	11.5
	E84AV□□□4534□□□ ¹⁾	EZAELN3100B301	100	139 x 267 x 205	16.5	

¹⁾ Operation only permitted with mains choke

4.6

Inverter Drives 8400 HighLine

Accessories



Interference suppression

RFI and mains filters are used to ensure compliance with the EMC requirements of European Standard EN 61800-3. This standard defines the EMC requirements for electrical drive system in various categories. **Category C1** applies to public networks (residential areas). Category C1 corresponds to Class B with regard to the limit values of Class B in line with EN 55011.

Category C2 is applicable in industrial premises; use in residential areas is left to the user's discretion. With regard to limit values, Category C2 corresponds to Class A according to EN 55011.





RFI filters

When working with stricter line-bound noise emission requirements, which cannot be met using the radio interference suppression measures integrated in the inverter (C2 up to 25 m shielded motor cable), external filters can be used. The filters can be installed below or next to the inverters.

Available RFI and mains filters

Mode	RFI filter LL (Low Leakage) E84AZESR□□□□LL	RFI filter SD (Short Distance) E84AZESR□□□□SD	RFI filter LD (Long Distance) E84AZESR□□□□LD	Mains filter LD (Long Distance) IOFAE□□□□F100D000□S
Category C1	Up to 5 m shielded motor cable ¹⁾	Up to 25 m shielded motor cable ¹⁾	Up to 50 m shielded motor cable ¹⁾	Up to 50 m shielded motor cable ¹⁾
Category C2		Up to 50 m shielded motor cable ¹⁾	Up to 100 m shielded motor cable ¹⁾	Up to 100 m shielded motor cable ¹⁾
Power range	0.25 to 2.2 kW, 230 V	0.25 to 15 kW	0.25 to 18.5 kW	22 to 45 kW
Features	<ul style="list-style-type: none"> For installation in mobile systems, leakage current < 3.5 mA (up to 5 m shielded motor cable) 	<ul style="list-style-type: none"> Optimised for low leakage current. 	<ul style="list-style-type: none"> 0,25 up to 15 kW: 50 - 100 m at max. 40 °C ambient temperature and max. 4 kHz switching frequency. 	<ul style="list-style-type: none"> Combination of mains choke and RFI filter.

¹⁾   37 - Details on maximum motor cable lengths.



Interference suppression

Operation at rated power

► RFI filter LL (Low Leakage)

Typical motor power 4-pole asynchronous motor	Mains voltage U_{AC}	Product key		Rated current I_N	Dimensions h x b x t	Mass
		Inverter	RFI filter			
P [kW]	U_{AC} [V]			[A]	[mm]	[kg]
0.25	1 AC 180 ... 264	E84AV□□□2512□□□	E84AZESR3712LL	5.00	212 x 70 x 60	0.8
0.37		E84AV□□□3712□□□				
0.55		E84AV□□□5512□□□	E84AZESR7512LL	9.00	262 x 70 x 60	1.0
0.75		E84AV□□□7512□□□				
1.10		E84AV□□□1122□□□	E84AZESR2222LL	22.0	317 x 70 x 60	1.6
1.50		E84AV□□□1522□□□				
2.20		E84AV□□□2222□□□				

► RFI filter SD (Short Distance)

Typical motor power 4-pole asynchronous motor	Mains voltage U_{AC}	Product key		Rated current I_N	Dimensions h x b x t	Mass
		Inverter	RFI filter			
P [kW]	U_{AC} [V]			[A]	[mm]	[kg]
0.25	1 AC 180 ... 264	E84AV□□□2512□□□	E84AZESR3712SD	5.00	212 x 70 x 60	0.8
0.37		E84AV□□□3712□□□				
0.55		E84AV□□□5512□□□	E84AZESR7512SD	9.00	262 x 70 x 60	1.0
0.75		E84AV□□□7512□□□				
1.10		E84AV□□□1122□□□	E84AZESR2222SD	22.0	317 x 70 x 60	1.6
1.50		E84AV□□□1522□□□				
2.20		E84AV□□□2222□□□				
0.37		E84AV□□□3714□□□				
0.55	E84AV□□□5514□□□					
0.75	E84AV□□□7514□□□					
1.10	E84AV□□□1124□□□	E84AZESR2224SD	7.30	317 x 70 x 60	1.4	
1.50	E84AV□□□1524□□□					
2.20	E84AV□□□2224□□□					
3.00	E84AV□□□3024□□S					E84AZESR3024SD
4.00	E84AV□□□3024□□0	E84AZESR5524SD	18.0	306 x 140 x 60	3.1	
5.50	E84AV□□□4024□□□					
7.50	E84AV□□□5524□□□					
11.0	E84AV□□□7524□□□	E84AZESR1534SD	29.0	361 x 140 x 60	4.4	
15.0	E84AV□□□1134□□□					
		E84AV□□□1534□□□				



Interference suppression

Operation at rated power

► RFI filter LD (Long Distance)

Typical motor power 4-pole asynchronous motor	Mains voltage	Product key		Rated current	Dimensions	Mass		
		Inverter	RFI filter					
P	U _{AC}			I _N	h x b x t	m		
[kW]	[V]			[A]	[mm]	[kg]		
0.25	1 AC 180 ... 264	E84AV□□□2512□□□	E84AZESR3712LD	5.00	212 x 70 x 60	0.8		
0.37		E84AV□□□3712□□□						
0.55		E84AV□□□5512□□□	E84AZESR7512LD					
0.75		E84AV□□□7512□□□						
1.10		E84AV□□□1122□□□	E84AZESR2222LD					
1.50		E84AV□□□1522□□□						
2.20		E84AV□□□2222□□□						
0.37		E84AV□□□3714□□□					E84AZESR7514LD	3.30
0.55	E84AV□□□5514□□□							
0.75	E84AV□□□7514□□□							
1.10	E84AV□□□1124□□□	E84AZESR2224LD						
1.50	E84AV□□□1524□□□							
2.20	E84AV□□□2224□□□	E84AZESR3024LD	7.30	317 x 70 x 60	1.2			
3.00	E84AV□□□3024□□S							
4.00	E84AV□□□3024□□0	E84AZESR5524LD	9.80	317 x 70 x 60	1.3			
5.50	E84AV□□□4024□□□							
7.50	E84AV□□□5524□□□	E84AZESR1534LD	18.0	306 x 140 x 60	2.4			
11.0	E84AV□□□7524□□□							
15.0	E84AV□□□1134□□□							
18.5	E84AV□□□1534□□□							
		E84AV□□□1834□□□	I0FAE318F100D0000S	50.4	436 x 205 x 90	7.1		

4.6

► Mains filter LD (Long Distance)

Typical motor power 4-pole asynchronous motor	Mains voltage	Product key		Rated current	Dimensions	Mass
		Inverter	Mains filter			
P	U _{AC}			I _N	h x b x t	m
[kW]	[V]			[A]	[mm]	[kg]
22.0	3 AC 320 ... 550	E84AV□□□2234□□□	I0FAE322F100D0000S	43.0	436 x 205 x 90	14.0
30.0		E84AV□□□3034□□□	I0FAE330F100D0000S	55.0	590 x 250 x 105	23.0
37.0		E84AV□□□3734□□□	I0FAE337F100D0000S	69.0		25.0
45.0		E84AV□□□4534□□□	I0FAE345F100D0001S	100	519 x 250 x 105	32.0



Interference suppression

Operation with increased power output

► RFI filter LL (Low Leakage)

Typical motor power 4-pole asynchronous motor	Mains voltage	Product key		Rated current	Dimensions	Mass
		Inverter	RFI filter			
P	U_{AC}			I_N	$h \times b \times t$	m
[kW]	[V]			[A]	[mm]	[kg]
0.37	1 AC 180 ... 264	E84AV□□□2512□□□	E84AZESR3712LL	5.00	212 x 70 x 60	0.8
0.55		E84AV□□□3712□□□				
0.75		E84AV□□□5512□□□	E84AZESR7512LL	9.00	262 x 70 x 60	1.0
1.10		E84AV□□□7512□□□				
1.50		E84AV□□□1122□□□				
2.20		E84AV□□□1522□□□	E84AZESR2222LL	22.0	317 x 70 x 60	1.6

► RFI filter SD (Short Distance)

Typical motor power 4-pole asynchronous motor	Mains voltage	Product key		Rated current	Dimensions	Mass
		Inverter	RFI filter			
P	U_{AC}			I_N	$h \times b \times t$	m
[kW]	[V]			[A]	[mm]	[kg]
0.37	1 AC 180 ... 264	E84AV□□□2512□□□	E84AZESR3712SD	5.00	212 x 70 x 60	0.8
0.55		E84AV□□□3712□□□				
0.75		E84AV□□□5512□□□	E84AZESR7512SD	9.00	262 x 70 x 60	1.0
1.10		E84AV□□□7512□□□				
1.50		E84AV□□□1122□□□				
2.20		E84AV□□□1522□□□	E84AZESR2222SD	22.0	317 x 70 x 60	1.6
0.55		3 AC 320 ... 550	E84AV□□□3714□□□	E84AZESR7514SD	3.30	262 x 70 x 60
0.75	E84AV□□□5514□□□					
1.10	E84AV□□□7514□□□		E84AZESR2224SD	7.30	317 x 70 x 60	1.4
1.50	E84AV□□□1124□□□					
2.20	E84AV□□□1524□□□					
3.00	E84AV□□□2224□□□		E84AZESR3024SD	9.80	317 x 70 x 60	1.5
4.00	E84AV□□□3024□□□S					
5.50	E84AV□□□4024□□□		E84AZESR5524SD	18.0	306 x 140 x 60	3.1
7.50	E84AV□□□5524□□□					
11.0	E84AV□□□7524□□□		E84AZESR1534SD	29.0	361 x 140 x 60	4.4
15.0	E84AV□□□1134□□□					



Interference suppression

Operation with increased power output

► RFI filter LD (Long Distance)

Typical motor power 4-pole asynchronous motor	Mains voltage	Product key		Rated current	Dimensions	Mass	
		Inverter	RFI filter				
P	U_{AC}			I_N	$h \times b \times t$	m	
[kW]	[V]			[A]	[mm]	[kg]	
0.37	1 AC 180 ... 264	E84AV□□□2512□□□	E84AZESR3712LD	5.00	212 x 70 x 60	0.8	
0.55		E84AV□□□3712□□□					
0.75		E84AV□□□5512□□□	E84AZESR7512LD	9.00	262 x 70 x 60	1.0	
1.10		E84AV□□□7512□□□					
1.50		E84AV□□□1122□□□	E84AZESR2222LD	22.0	317 x 70 x 60	1.6	
2.20		E84AV□□□1522□□□					
0.55	3 AC 320 ... 550	E84AV□□□3714□□□	E84AZESR7514LD	3.30	262 x 70 x 60	1.1	
0.75		E84AV□□□5514□□□					
1.10		E84AV□□□7514□□□	E84AZESR2224LD	7.30	317 x 70 x 60	1.2	
1.50		E84AV□□□1124□□□					
2.20		E84AV□□□1524□□□	E84AZESR3024LD	9.80	306 x 140 x 60	1.3	
3.00		E84AV□□□2224□□□					
4.00		E84AV□□□3024□□S	E84AZESR5524LD	18.0	361 x 140 x 60	3.3	
5.50		E84AV□□□3024□□0					
7.50		E84AV□□□4024□□□	E84AZESR1534LD	29.0	361 x 140 x 60	3.3	
11.0		E84AV□□□5524□□□					
15.0		E84AV□□□7524□□□					
			E84AV□□□1134□□□				

4.6

► Mains filter LD (Long Distance)

Typical motor power 4-pole asynchronous motor	Mains voltage	Product key		Rated current	Dimensions	Mass
		Inverter	Mains filter			
P	U_{AC}			I_N	$h \times b \times t$	m
[kW]	[V]			[A]	[mm]	[kg]
22.0	3 AC 320 ... 550	E84AV□□□1834□□□	I0FAE322F100D0000S	43.0	436 x 205 x 90	14.0
30.0		E84AV□□□2234□□□	I0FAE322F100D0001S	55.0	365 x 205 x 90	18.5
37.0		E84AV□□□3034□□□	I0FAE337F100D0000S	69.0	590 x 250 x 105	25.0
45.0		E84AV□□□3734□□□	I0FAE345F100D0001S	100	519 x 250 x 105	32.0
55.0		E84AV□□□4534□□□				



Sinusoidal filters

A sinusoidal filter in the motor cable limits the rate of voltage rise and the capacitive charge/discharge currents that occur during inverter operation.

Application range:

- Only use a sinusoidal filter with standard asynchronous motors of 0 ... 550 V
- Operation only with V/f or V/f² characteristic control
- Set the switching frequency permanently to the specified value
- Limit the output frequency of the Inverter Drives 8400 to the specified value



Sinusoidal filters

Operation at rated power

Typical motor power	Mains voltage	Product key		Rated inductance	Switching frequency	Mass	
4-pole asynchronous motor		Inverter	Sinusoidal filter				
P	U _{AC}			L _N	f _{ch}	m	
[kW]	[V]			[mH]	[kHz]	[kg]	
0.37	3 AC 320 ... 550	E84AV□□□3714□□□	EZS3-004A200	11.0	4 8	4.0	
0.55		E84AV□□□5514□□□					
0.75		E84AV□□□7514□□□					
1.10		E84AV□□□1124□□□					
1.50		E84AV□□□1524□□□	EZS3-010A200	5.10		5.5	
2.20		E84AV□□□2224□□□					
3.00		E84AV□□□3024□□□					
4.00		E84AV□□□4024□□□	EZS3-017A200	3.07		8.5	
5.50		E84AV□□□5524□□□					
7.50		E84AV□□□7524□□□	EZS3-024A200	2.50		14.5	
11.0		E84AV□□□1134□□□	EZS3-032A200	2.00		19.0	
15.0		E84AV□□□1534□□□	EZS3-037A200	1.70		21.0	
18.5		E84AV□□□1834□□□	EZS3-048A200	1.20		25.5	
22.0		E84AV□□□2234□□□	EZS3-061A200	1.00		33.5	
30.0		E84AV□□□3034□□□	EZS3-072A200	0.95		37.0	
37.0		E84AV□□□3734□□□	EZS3-090A200	0.80		53.0	
45.0		E84AV□□□4534□□□	EZS3-115A200	0.70		2 4	66.0

Inverter Drives 8400 HighLine

Accessories



Sinusoidal filters

Operation with increased power output

Typical motor power 4-pole asynchronous motor	Mains voltage U_{AC}	Product key		Rated inductance L_N	Switching frequency f_{ch}	Mass m	
		Inverter	Sinusoidal filter				
P [kW]	U_{AC} [V]			L_N [mH]	f_{ch} [kHz]	m [kg]	
0.55	3 AC 320 ... 550	E84AV□□□3714□□□	EZS3-010A200	5.10	4 8	5.5	
0.75		E84AV□□□5514□□□					
1.10		E84AV□□□7514□□□					
1.50		E84AV□□□1124□□□					
2.20		E84AV□□□1524□□□					
3.00		E84AV□□□2224□□□					
4.00		E84AV□□□3024□□□	EZS3-017A200	3.07		8.5	
5.50		E84AV□□□4024□□□	EZS3-024A200	2.50		14.5	
7.50		E84AV□□□5524□□□					
11.0		E84AV□□□7524□□□	EZS3-037A200	1.70		21.0	
15.0		E84AV□□□1134□□□					
22.0		E84AV□□□1834□□□	EZS3-061A200	1.00		33.5	
30.0		E84AV□□□2234□□□					
37.0		E84AV□□□3034□□□	EZS3-072A200	0.95		37.0	
45.0		E84AV□□□3734□□□	EZS3-090A200	0.80		53.0	
55.0		E84AV□□□4534□□□	EZS3-115A200	0.70		2 4	66.0

4.6

Inverter Drives 8400 HighLine

Accessories



Rated data for power supply modules

► The data is valid for operation at 3/PE AC 400 V.

						
Product key						
Power supply module			E94APNE0104	E94APNE0364	E94APNE1004	E94APNE2454
Rated power						
With mains filter/mains choke	P_N	[kW]	4.90	17.5	48.6	119
Without mains filter/mains choke	P_N	[kW]	3.60	13.0	36.2	88.6
Mains voltage range			3/PE AC 340 V-0% ... 528 V+0 %, 45 Hz-0 % ... 65 Hz+0 %			
Rated mains current						
	$I_{N,AC}$	[A]	8.0	29.0	82.0	200.0
Rated DC-bus current						
	$I_{N,DC}$	[A]	10.0	36.0	100.0	245.0

Data for 60 s overload

Max. DC-bus current						
	I_{max}	[A]	15.0	54.0	150.0	368.0
Reduced DC-bus current						
	$I_{red,DC}$	[A]	7.5	27.0	75.0	183.5
Overload time						
	t_{ol}	[s]	120.0			
Recovery time						
	t_{re}	[s]	60.0			
Max. output power¹⁾						
	$P_{max,1}$	[kW]	7.4	26.3	72.9	179.0

Data for 0.5 s overload

Max. short-time DC-bus current						
	I_{max}	[A]	40.0	108.0	200.0	368.0
Reduced DC-bus current						
	$I_{red,DC}$	[A]	7.5	27.0	75.0	183.5
Overload time						
	t_{ol}	[s]	0.5			
Recovery time						
	t_{re}	[s]	4.5			
Max. short-term output power¹⁾						
	$P_{max,2}$	[kW]	19.6	52.5	146.0	357.0

¹⁾ Mains filter required; if no mains filter is installed, the stated values for P_{max} decrease





Inverter Drives 8400 HighLine

Accessories



Rated data for power supply modules

► The data is valid for operation at 3/PE AC 400 V.

						
Product key						
Power supply module			E94APNE0104	E94APNE0364	E94APNE1004	E94APNE2454
Rated power						
With mains filter/mains choke	P_N	[kW]	4.90	17.5	48.6	119
Without mains filter/mains choke	P_N	[kW]	3.60	13.0	36.2	88.6
Rated DC-bus current						
	$I_{N,DC}$	[A]	10.0	36.0	100.0	245.0
Power loss						
	P_V	[kW]	0.055	0.110	0.230	0.550
Dimensions						
Height	h	[mm]	350		383	
Height, including fastening	h	[mm]	481		510	
Width	b	[mm]	60	120	210	390
Depth	t	[mm]	288			
Mass						
	m	[kg]	2.6	5.3	13.5	28.5

4.6

Brake chopper rated data

Rated power, Brake chopper						
	P_N	[kW]	2.6	8.7	17.0	30.3
Max. output power, Brake chopper						
	$P_{max,1}$	[kW]	19.5	43.8	105.1	187.7
Running time						
	t_{on}	[s]	1.0			
Recovery time						
	t_{re}	[s]	3.8	2.5	3.1	
Min. brake resistance						
	R_{min}	[Ω]	27.0	12.0	5.0	2.8



Rated data for regenerative power supply modules

- ▶ The data is valid for operation at 3/PE AC 400 V.
- ▶ Mains filter required, please refer to the following pages

						
Product key			E94ARNE0134		E94ARNE0244	
Supply- / regenerative module			E94ARNE0134		E94ARNE0244	
Operating mode			Feed	Feedback	Feed	Feedback
Rated power						
With mains filter/mains choke	P_N	[kW]	15.0	7.50	27.0	13.5
Mains voltage range			3/PE AC 340 V-0% ... 528 V+0%, 45 Hz-0% ... 65 Hz+0%			
	U_{AC}	[V]				
Rated mains current						
	$I_{N, AC}$	[A]	26.0	13.0	47.0	23.5
Rated DC-bus current						
	$I_{N, DC}$	[A]	32.0	16.0	57.0	29.0

4.6

Data for 60 s overload

Max. DC-bus current						
	I_{max}	[A]	48.0	24.0	86.0	44.0
Reduced DC-bus current						
	$I_{red, DC}$	[A]	20.0	9.8	35.0	18.0
Overload time			60.0			
	t_{ol}	[s]				
Recovery time			120.0			
	t_{re}	[s]				
Max. output power						
	$P_{max, 1}$	[kW]	22.4	11.2	40.5	20.2

Data for 0.5 s overload

Max. short-time DC-bus current						
	I_{max}	[A]	96.0	48.0	171.0	87.0
Reduced DC-bus current						
	$I_{red, DC}$	[A]	20.0	9.8	35.0	18.0
Max. short-term output power						
	$P_{max, 2}$	[kW]	44.9	22.4	81.1	40.5
with brake chopper support						
	$P_{max, 2}$	[kW]		35.1		59.6



Rated data for regenerative power supply modules

- ▶ The data is valid for operation at 3/PE AC 400 V.
- ▶ Mains filter required, please refer to the following pages

						
Product key			E94ARNE0134		E94ARNE0244	
Supply- / regenerative module						
Operating mode			Feed	Feedback	Feed	Feedback
Rated power						
With mains filter/mains choke	P_N	[kW]	15.0	7.50	27.0	13.5
Rated DC-bus current						
	$I_{N,DC}$	[A]	32.0	16.0	57.0	29.0
Power loss						
	P_V	[kW]	0.150	0.110	0.230	0.190
Dimensions						
Height	h	[mm]	350			
Height, including fastening	h	[mm]	481			
Width	b	[mm]	120			
Depth	t	[mm]	288			
Mass						
	m	[kg]	6.0			

4.6

Brake chopper rated data

Rated power, Brake chopper				
	P_N	[kW]	4.7	9.3
Max. output power, Brake chopper				
	$P_{max,1}$	[kW]	19.5	29.2
Running time				
	t_{on}	[s]	1.0	
Recovery time				
	t_{re}	[s]	4.2	3.9
Min. brake resistance				
	R_{min}	[Ω]	27.0	18.0



Control connections

Mode	Power supply modules	Regenerative power supply modules
Analog inputs		
Number		2
Resolution		11 bits + sign
Value range		+/- 10V 1 x switchable 20mA
Analog outputs		
Number		2
Resolution		10 bits + sign
Value range		+/- 10V max. 2 mA
Digital inputs		
Number	1 Permanently configured	8
Switching level	PLC (IEC 61131-2)	
Max. input current	8mA	
Digital outputs		
Number	4 fest konfiguriert	4
Switching level	PLC (IEC 61131-2)	
Max. output current	50mA per output	
Load capacity	>480 Ω at 24 V	
External DC supply		
Rated voltage	24 V in accordance with IEC 61131-2	
Voltage range	19.2 ... 28.8 V, max. residual ripple ± 5%	
Current	Approx. 1.4 A during operation, max. 4 A starting current for 100 ms	Approx. 1.2 A during operation, max. 3 A starting current for 100 ms ¹⁾
Interfaces		
CANopen		Integrated
Extensions		Via slot MXI 2: extension 2 Via slot MXI 1: extension 1
State bus		Integrated
Memory		Slot MMI
Safety engineering		Slot MSI
Drive interface		
Resolver input		Integrated (no function)
Mains synchronisation input		Integrated Sub-D, 15-pin

¹⁾ The supply to the control electronics comes from the mains voltage. Alternatively, it can be provided by a 24 V supply that is independent of the mains (available as an option).



Brake resistors of the regenerative power supply modules

Assignment of brake resistors to the supply and regenerative power supply modules is shown in the tables below.



Brake resistor 27 ohms

Brake resistors for power supply modules

Rated power	Mains voltage	Product key		Rated resistance	Rated power	Thermal capacity	Dimensions	Mass
		Power supply module	Brake resistor					
P_N	U_{AC}			R_N	P_N	C_{th}	$h \times b \times t$	m
[kW]	[V]			[Ω]	[kW]	[KWs]	[mm]	[kg]
3.60	3 AC 340 ... 528 ¹⁾	E94APNE0104	ERBP027R200W	27.0	0.20	30.0	320 x 41 x 122	1.0
			ERBS027R600W		0.60	90.0	550 x 110 x 105	3.1
			ERBS027R01K2		1.20	180	1020 x 110 x 105	5.6
13.0		E94APNE0364	ERBG012R01K9	12.0	1.90	285	486 x 236 x 302	13.0
			ERBG012R05K2		5.20	750	486 x 426 x 302	28.0
36.2		E94APNE1004	ERBG005R02K6	5.0	2.60	390	486 x 326 x 302	12.6
88.6		E94APNE2454	ERBG028D04K1	2.8	4.10	615	486 x 426 x 302	12.8

¹⁾ For 230 V mains voltage a different brake resistor assignment applies.

4.6

Brake resistors for regenerative power supply modules

Rated power	Mains voltage	Product key		Rated resistance	Rated power	Thermal capacity	Dimensions	Mass
		Supply- / regenerative module	Brake resistor					
P_N	U_{AC}			R_N	P_N	C_{th}	$h \times b \times t$	m
[kW]	[V]			[Ω]	[kW]	[KWs]	[mm]	[kg]
15.0	3 AC 340 ... 528 ¹⁾	E94ARNE0134	ERBP027R200W	27.0	0.20	30.0	320 x 41 x 122	1.0
			ERBS027R600W		0.60	90.0	550 x 110 x 105	3.1
			ERBS027R01K2		1.20	180	1020 x 110 x 105	5.6
27.0		E94ARNE0244	ERBP018R300W	18.0	0.30	30.0	240 x 41 x 122	1.4
			ERBS018R01K2		1.20	180	1020 x 110 x 105	5.6
			ERBS018R02K8		2.80	420	1110 x 200 x 105	12.0

²⁾ For 230 V mains voltage a different brake resistor assignment applies.



Mains chokes of the power supply modules

A mains choke is an inductive resistor which is connected in the mains cable of the power supply module. The use of a mains choke provides the following advantages:

- **Fewer effects on the mains:**
The wave form of the mains current is a close approximation to a sine wave.
- **Reduction in the effective mains current:**
Reduction of mains, cable and fuse loads

Mains chokes can be used without restrictions in conjunction with RFI filters and/or sinusoidal filters.

Please note:

: The use of a mains choke slightly reduces the mains voltage at the input of the inverter - the typical voltage drop across the mains choke at the rated values is around 4%.



Mains choke

Rated power	Mains voltage	Product key		Rated current	Dimensions	Mass
		Power supply module	Mains choke			
P_N	U_{AC}			I_N	$h \times b \times t$	m
[kW]	[V]			[A]	[mm]	[kg]
4.90	3 AC 340 ... 528	E94APNE0104	EZAELN3008B372	8.00	85 x 120 x 140	1.9
17.5		E94APNE0364	EZAELN3030B982	30.0	110 x 155 x 167	5.9
48.6		E94APNE1004	EZAELN3080B371	80.0	125 x 210 x 240	12.5
119		E94APNE2454	EZAELN3200B151	200	352 x 144 x 264	32.0



Interference suppression of the regenerative power supply modules

RFI filters and mains filters enable compliance with the interference voltage categories of the European standard EN 61800-3. There a distinction is drawn between category C1 and category C2.

Category C1 describes the use on public supply networks.

Category C2 describes the use of drives which are intended to be used for industrial purposes in areas also comprising residential areas.

For Multi Drives external filters must be used to comply with the EMC Directive.



RFI filter, can be mounted beside the power supply module

RFI filters

RFI filters are primarily capacitive accessory components which can be connected directly upstream from the power supply modules. This measure enables compliance with the corresponding conducted noise emission requirements according to EN 61800-3.

Rated power	Mains voltage	Product key		Rated current	Power loss	Max. cable length	Dimensions	Mass
		Power supply module	RFI filter					
Without mains filter/mains choke						Reference group C2		
P_N	U_{AC}			I_N	P_V	l_{max}	$h \times b \times t$	m
[kW]	[V]			[A]	[kW]	[m]	[mm]	[kg]
3.60	3 AC 340 ... 528	E94APNE0104	E94AZRP0084	8.00	0.020	6 axes of 10 m each	485 x 60 x 261	4.2
13.0		E94APNE0364	E94AZRP0294	29.0	0.050			4.5
36.2		E94APNE1004	E94AZRP0824	82.0	0.080		490 x 209 x 272	18.5
88.6		E94APNE2454	E94AZRP2004	200	0.150			20.5

4.6

The following diagram shows the possible number of axes and the possible sum of motor cable lengths to ensure compliance with interference suppression according to category C2.

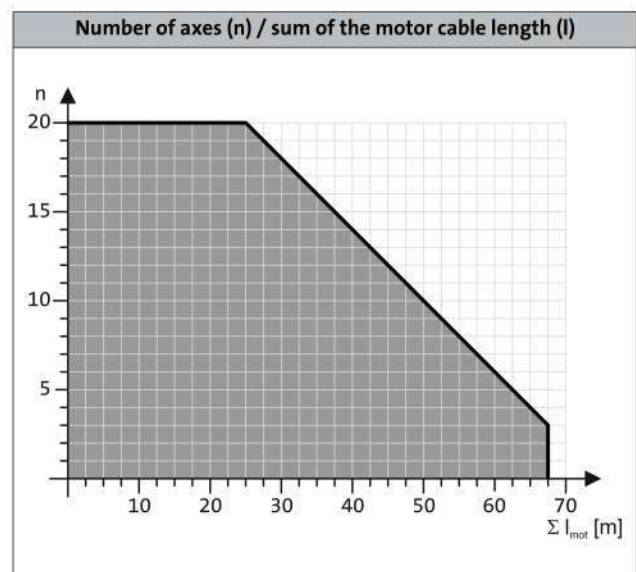



Interference suppression of the regenerative power supply modules

Mains filters

A mains filter is a combination of mains choke and RFI filter in a single housing. It reduces line-bound noise emission into the mains, thus ensuring that the line-bound interference voltage is reduced to a permissible level according to EN61800-3.



Mains filter, can be mounted beside the power supply modules (right) or the regenerative power supply modules (left)

RFI filters

Rated power	Mains voltage	Product key		Rated current	Voltage drop	Max. cable length	Dimensions	Mass
		Power supply module	Mains filter					
With mains filter/mains choke						Reference group C2		
P_N	U_{AC}			I_N	U	I_{max}	$h \times b \times t$	m
[kW]	[V]			[A]	[V]	[m]	[mm]	[kg]
4.90	3 AC 340 ... 528	E94APNE0104	E94AZMP0084	8.00	10.0	10 axes of 50 m each	485 x 90 x 261	8.6
17.5		E94APNE0364	E94AZMP0294	29.0	7.3		485 x 120 x 261	16.5
48.6		E94APNE1004	E94AZMP0824 ¹⁾	82.0	6.4		490 x 270 x 272	29.0
119		E94APNE2454	E94AZMP2004 ¹⁾	200	6.3		490 x 330 x 272	52.0

¹⁾ External 24 V supply from a safely separated power supply unit (SELV/PELV) required for integrated fan.

The following diagram shows the possible number of axes and the possible sum of motor cable lengths to ensure compliance with interference suppression according to category C2.

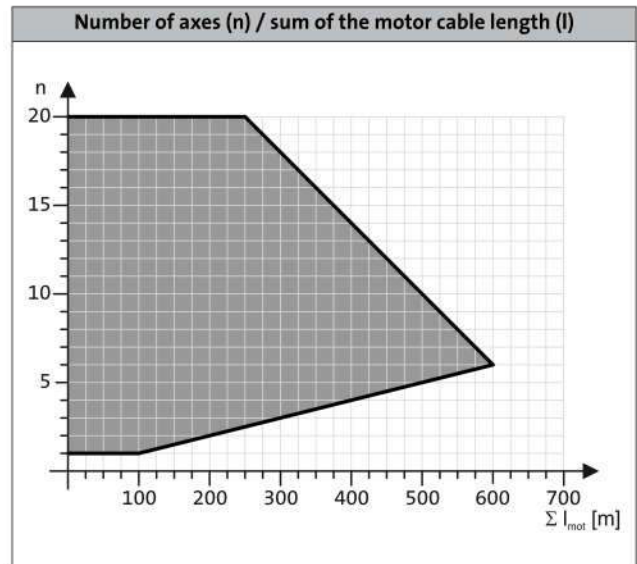



Interference suppression of the regenerative power supply modules

Mains filters for regenerative power supply modules

Rated power	Mains voltage	Product key		Rated current	Voltage drop	Max. cable length	Dimensions	Mass
		Supply- / regenerative module	Mains filter					
With mains filter/mains choke						Reference group C2		
P_N	U_{AC}			I_N	U	I_{max}	$h \times b \times t$	m
[kW]	[V]			[A]	[V]	[m]	[mm]	[kg]
15.0	3 AC 340 ... 528	E94ARNE0134	E94AZMR0264SDB ¹⁾	26.0	6.3	6 axes of 10 m each	485 x 149 x 272	25.0
			E94AZMR0264LDB ¹⁾			10 axes of 50 m each		26.0
27.0		E94ARNE0244	E94AZMR0474SDB ¹⁾	47.0	6.2	6 axes of 10 m each	485 x 209 x 272	36.0
			E94AZMR0474LDB ¹⁾			10 axes of 50 m each		37.0

¹⁾ External 24 V supply through safely separated power supply unit (SELV/PELV) required for integrated mains voltage recording.



DC input module

Via a DC input module, an axis module interconnection can be supplied with power from a central DC source (power supply module, Single Drive axis modules, Multi Drive axis modules). This is required for example if a drive system with a multi-level structure installed in a control cabinet is to be supplied via a central DC power supply unit. The rated current of the DC input module is defined to be 100 A (DC). The DC input module can be connected at the top or bottom, offering great flexibility with regard to integration into the system wiring. This provides an ideal way of connecting multi-row axis modules in particular.



DC input module
100 A

Mode	Product key	Dimensions	Mass
	Input module	h x b x t	m
		[mm]	[kg]
DC input module 100 A	E94AZEX100	422 x 60 x 95	0.9

4.6

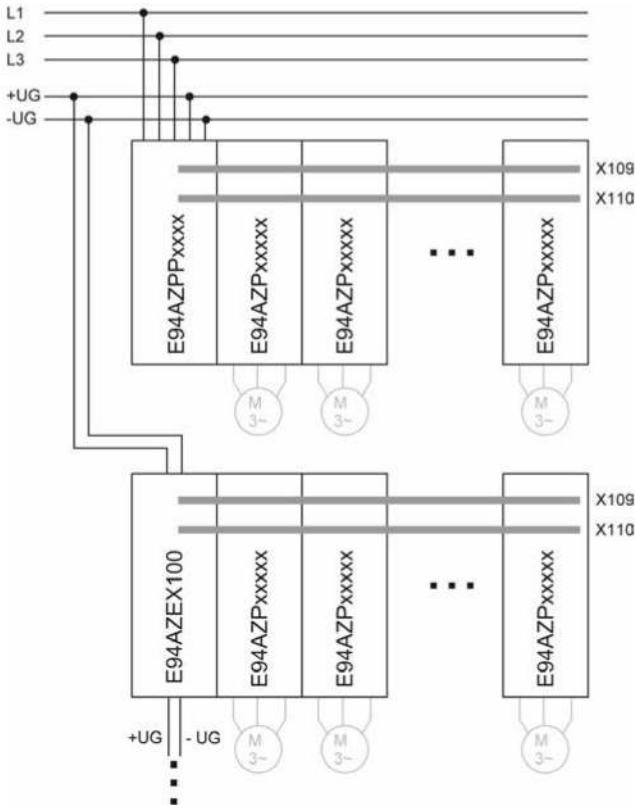

Wiring example for multi-row mounting of axis modules



DC-bus connection

The Inverter Drives 8400 can be operated in a DC-bus connection. The 400 V devices have a direct connection for this.

The components listed here are used to interconnect the individual devices for operation with or without a regenerative power supply module. With a DC-bus connection, energy can be exchanged between the individual devices. This makes particular sense with cyclic operation of multiple devices.

The design of a DC-bus connection requires extremely precise dimensioning of the devices' energy requirements among one another. Lenze Sales is happy to advise you here to ensure the most energy-efficient drive dimensioning. The components listed here form the basis for this.

- ▶ Two DC fuses are always required.
- ▶ The fuse holders EFH10005 and EFH10004 are single-pole, while the holders EFH20005 and EFH20007 are 2-pole.
- ▶ The fuses are not UL-approved for the DC operation.
- ▶ Please consult Lenze Sales to ensure the right dimensioning.

Components for DC-bus connection

Product key	Rated current	Design
DC fuses		
	I_N	
	[A]	
EFSGR0060AYHN	6.00	14x51 without indicator
EFSGR0100AYHN	10.0	
EFSGR0160AYHN	16.0	
EFSGR0200AYHN	20.0	
EFSGR0250AYHN	25.0	
EFSGR0320AYHN	32.0	
EFSGR0400AYHN	40.0	
EFSGR0060AYHK	6.00	14x51 with indicator
EFSGR0100AYHK	10.0	
EFSGR0160AYHK	16.0	
EFSGR0200AYHK	20.0	
EFSGR0250AYHK	25.0	
EFSGR0320AYHK	32.0	
EFSGR0400AYHK	40.0	

Product key	Rated current	Design
DC fuses		
	I_N	
	[A]	
EFSGR0120AYIN	12.0	22x58 without indicator
EFSGR0160AYIN	16.0	
EFSGR0200AYIN	20.0	
EFSGR0250AYIN	25.0	
EFSGR0320AYIN	32.0	
EFSGR0400AYIN	40.0	
EFSGR0500AYIN	50.0	
EFSGR0800AYIN	80.0	22x58 with indicator
EFSGR0120AYIK	12.0	
EFSGR0160AYIK	16.0	
EFSGR0200AYIK	20.0	
EFSGR0250AYIK	25.0	
EFSGR0320AYIK	32.0	
EFSGR0400AYIK	40.0	
EFSGR0500AYIK	50.0	
EFSGR0800AYIK	80.0	

Mode	Features	Product key
DC busbar	• Busbar system 14 x 51 • DC busbar length 1m, cross-section 25 mm ²	EWZ0036
	• Busbar system 22 x 58 • DC busbar length 1m, cross-section 25 mm ²	EWZ0037
End cap	• End caps for DC busbar (packaging unit 10 pcs)	EWZ0038
Terminal	• Single-pole terminal for internal supply	EWZ0039

Inverter Drives 8400 HighLine

Accessories



DC-bus connection

DC fuses size 14 x 51 mm

Typical motor power 4-pole asynchronous motor	Mains voltage U_{AC}	Product key				
		Inverter	DC fuses			
P [kW]	[V]					
0.37	3 AC 320... 550	E84AV□□□3714□□□	EFSGR0160AYHN	EFH20005	EFSGR0160AYHK	EFH10005
0.55		E84AV□□□5514□□□				
0.75		E84AV□□□7514□□□				
1.10		E84AV□□□1124□□□				
1.50		E84AV□□□1524□□□				
2.20		E84AV□□□2224□□□	EFSGR0200AYHN		EFSGR0200AYHK	
3.00		E84AV□□□3024□□□				
4.00		E84AV□□□4024□□□				
5.50		E84AV□□□5524□□□	EFSGR0400AYHN		EFSGR0400AYHK	
7.50		E84AV□□□7524□□□				
11.0		E84AV□□□1134□□□				
15.0		E84AV□□□1534□□□				

4.6

DC fuses size 22 x 58 mm

Typical motor power 4-pole asynchronous motor	Mains voltage U_{AC}	Product key				
		Inverter	DC fuses			
P [kW]	[V]					
0.37	3 AC 320... 550	E84AV□□□3714□□□	EFSGR0120AYIN	EFH20007	EFSGR0120AYIK	EFH10004
0.55		E84AV□□□5514□□□				
0.75		E84AV□□□7514□□□				
1.10		E84AV□□□1124□□□				
1.50		E84AV□□□1524□□□				
2.20		E84AV□□□2224□□□	EFSGR0200AYIN		EFSGR0200AYIK	
3.00		E84AV□□□3024□□□				
4.00		E84AV□□□4024□□□				
5.50		E84AV□□□5524□□□	EFSGR0400AYIN		EFSGR0400AYIK	
7.50		E84AV□□□7524□□□	EFSGR0500AYIN		EFSGR0500AYIK	
11.0		E84AV□□□1134□□□	EFSGR0800AYIN		EFSGR0800AYIK	
15.0		E84AV□□□1534□□□				

Inverter Drives 8400 HighLine

Accessories



24 V power supply unit

External power supply units are available for supplying the control electronics of the 8400 StateLine, HighLine or TopLine. With an external supply, the inverters can be parameterised and diagnosed while the mains input is deenergised.



24 V power supply unit

Rated data

Product key			EZV1200-000	EZV2400-000	EZV4800-000	EZV1200-001	EZV2400-001	EZV4800-001
Rated voltage								
AC	$U_{N,AC}$	[V]	230			400		
Input voltage								
	U_{in}	[V]	AC 85 ... 264 DC 90 ... 350			AC 320 ... 575 DC 450 ... 800		
Rated mains current								
	$I_{N,AC}$	[A]	0.8	1.2	2.3	0.3	0.6	1.0
Output voltage								
	U_{out}	[V]	DC 22.5 ... 28.5					
Rated output current								
	$I_{N,out}$	[A]	5.0	10.0	20.0	5.0	10.0	20.0
Dimensions								
Height	h	[mm]	130					
Width	b	[mm]	55	85	157	73	85	160
Depth	t	[mm]	125					
Mass								
	m	[kg]	0.8	1.2	2.5	1.0	1.1	1.9

4.6

Brake switch

The brake switch consists of a rectifier and an electronic circuit breaker for the switching of an electromechanical brake switch. The brake switch is mounted on the control cabinet plate by means of two screws. Control is performed using a digital output on the inverter.



Brake switch

Mode	Features	Product key
Half-wave rectification	<ul style="list-style-type: none"> Input voltage: AC 320 ... 550 V Output voltage: DC 180 V (at AC 400 V), DC 225 V (at AC 500 V) Max. brake current: DC 0.61 A IP00 degree of protection 	E82ZWBRE
Bridge rectification	<ul style="list-style-type: none"> Input voltage: AC 180 ... 317 V Output voltage: DC 205 V (at AC 230 V) Max. brake current: DC 0.54 A IP00 degree of protection 	E82ZWBREB

Inverter Drives 8400 HighLine

Accessories



USB diagnostic adapter

The operation, parameter setting and diagnostics of the Inverter Drives 8400 and the Servo Drives 9400 via the L-force diagnostics is made with the keypad X400 or a PC. The connection of a PC can be made via a USB interface and the USB diagnostic adapter.

For connecting the USB diagnostic adapter with the L-force diagnostics interface (DIAG) at the inverter, three different connecting cables are separately available in the lengths 2.5 m, 5 m and 10 m. The connection can be established during operation. The engineering tools EASY Starter or Engineer can be used to carry out the operation, parameter setting or diagnostics of the inverters. Both tools have simple intuitive surfaces. This enables a quick and easy commissioning.

Optionally to the USB diagnostic adapter, the PC system bus adapter can be used. For this purpose, a CANopen interface must be available at the inverter.



USB diagnostic adapter incl. connecting cable to the PC

- The engineering tools EASY Starter or Engineer are used for operation, parameter setting and diagnostics of the inverters.

Mode		Features	Product key
USB diagnostic adapter		<ul style="list-style-type: none"> • Input-side voltage supply via USB connection on PC • Output-side voltage supply via inverter's diagnostic interface • Diagnostic LEDs • Electrical isolation of PC and inverter • Hot-pluggable 	E94AZCUS

Connecting cables for USB diagnostic adapter

Mode	Features	Product key
Connecting cable for USB diagnostic adapter	• Length: 2.5 m	EWL0070
	• Length: 5 m	EWL0071
	• Length: 10 m	EWL0072

Inverter Drives 8400 HighLine

Accessories



X400 keypad

As an alternative to the PC, the X400 keypad can be used for local operation, parameter setting or diagnostics. The X400 keypad plugs into the L-force diagnostics interface (DIAG) on the front of the inverter.



X400 keypad

Mode		Features	Slot	Product key
X400 keypad		<ul style="list-style-type: none"> • Menu navigation • Graphics display with background lightning for clear presentation of information • 4 navigation keys, 2 context-sensitive keys • Adjustable RUN/STOP function 	DIAG	EZAEBK1001

- ▶ The Inverter Drives 8400 can be ordered with a plug-in keypad already installed. If you would like to order the products in this complete form, please add the inverter product key as follows when placing your order: E84AV to X-XXXXX
- ▶ The product key with the supplement for the applied module is provided in our sales documents. This information is not part of the nameplate of the device.

X400 diagnosis terminal

Mode		Features	Slot	Product key
X400 diagnosis terminal		<ul style="list-style-type: none"> • X400 keypad in a robust housing • Also suitable for installation in the control cabinet door • incl. 2.5 m cable • IP20 degree of protection, IP65 for control cabinet installation on front face 	DIAG	EZAEBK2001



PC system bus adapter

The operation, parameterisation and diagnostics of the Inverter Drives 8400 using a PC can also be carried out via the CANopen interface using a PC system bus adapter. This requires a PC system bus adapter instead of a USB diagnostic adapter. This adapter is plugged into the parallel interface or USB connection of the PC. The corresponding drivers will be installed automatically. The voltage for the adapter is supplied via the USB connection of the PC. The CANopen interface is integrated or available with a variant (BaseLine C).

Advantage:

- Operation, parameterisation and diagnostics in parallel with the keypad
- In interconnected systems, multiple inverters can be addressed simultaneously from one point (remote parameterisation via CANopen)



EMF2177IB adapter

Mode	Features	Product key
PC system bus adapter	<ul style="list-style-type: none"> • Voltage supply via USB port on PC • Electrical isolation from the bus 	EMF2177IB

4.6

Shield mounting

A shield mounting is used to connect the motor cable shield on the inverter's shield connection.

Mode	Features	Product key
Metal cable tie	<ul style="list-style-type: none"> • Cable diameter: 8...30 mm • Packaging unit: 50 items 	EZAMBKBM
Fixing clip	<ul style="list-style-type: none"> • Cable diameter: 4...10 mm • Packaging unit: 20 items 	EZAMBHXM007/M
Wire clamp	<ul style="list-style-type: none"> • Cable diameter: 4...15 mm • Packaging unit: 10 items 	EZAMBHXM006/M
	<ul style="list-style-type: none"> • Cable diameter: 10...20 mm • Packaging unit: 10 items 	EZAMBHXM003/M
	<ul style="list-style-type: none"> • Cable diameter: 15...28 mm • Packaging unit: 10 items 	EZAMBHXM004/M
	<ul style="list-style-type: none"> • Cable diameter: 20...37 mm • Packaging unit: 10 items 	EZAMBHXM005/M

Inverter Drives 8400 HighLine

Accessories



Terminal strips

All connections are equipped with pluggable connectors, with power connections up to 15 kW. These pluggable connectors are available separately for service purposes or if cable harnesses need to be physically separated.

► Power connections

Product key	Terminal strip	Features	Product key	Terminal strip	Features	Product key
Inverter						
E84AV□□□2512□□□	X100	<ul style="list-style-type: none"> • Connection: mains • Packaging unit: 10 items 	E84AZEVS001X100/M	X105	<ul style="list-style-type: none"> • Connection: motor • Packaging unit: 5 items 	E84AZEVS010X105/M
E84AV□□□3712□□□			E84AZEVS002X100/M			
E84AV□□□5512□□□						
E84AV□□□7512□□□						
E84AV□□□1122□□□						
E84AV□□□1522□□□						
E84AV□□□2222□□□		<ul style="list-style-type: none"> • Connection: mains • Packaging unit: 5 items 			E84AZEVS003X100/M	
E84AV□□□3714□□□						
E84AV□□□5514□□□						
E84AV□□□7514□□□						
E84AV□□□1124□□□						
E84AV□□□1524□□□						
E84AV□□□2224□□□		E84AZEVS004X100/M				
E84AV□□□3024□□□						
E84AV□□□4024□□□						
E84AV□□□5524□□□						
E84AV□□□7524□□□						
E84AV□□□1134□□□			E84AZEVS005X100/M			
E84AV□□□1534□□□						

4.6

► Control connections

Terminal strip	Features	Product key
X1	<ul style="list-style-type: none"> • Connection: CANopen • Packaging unit: 10 items 	E84AZEVS040X001/M
X3	<ul style="list-style-type: none"> • Connection: analog inputs and outputs • Packaging unit: 5 items 	E84AZEVS060X003/M
X4	<ul style="list-style-type: none"> • Connection: digital outputs • Packaging unit: 10 items 	E84AZEVS060X004/M
X5	<ul style="list-style-type: none"> • Connection: digital inputs • Packaging unit: 5 items 	E84AZEVS060X005/M
X80	<ul style="list-style-type: none"> • Connection: safety engineering • Packaging unit: 10 items 	E84AZEVS070X080/M
X101	<ul style="list-style-type: none"> • Connection: relay • Packaging unit: 10 items 	E84AZEVS020X101/M
X106	<ul style="list-style-type: none"> • Connection: PTC • Packaging unit: 10 items 	E84AZEVS030X106/M
X107	<ul style="list-style-type: none"> • Connection: 2.5 A digital output • Packaging unit: 10 items 	E84AZEVS060X107/M



Setpoint potentiometer

The setpoint selection (e.g. speed) can be made via an external potentiometer.
The setpoint potentiometer is connected to the inverter's analog input terminals. A scale and a rotary knob are also available.



Setpoint potentiometer with scale and rotary knob

Mode	Product key
10 kOhm / 1 Watt potentiometer	ERPD0010K0001W
Rotary knob, 36 mm diameter	ERZ0001
Scale 0 ... 100%, 62 mm diameter	ERZ0002

Inverter Drives 8400 HighLine

Accessories



Inverter Drives 8400 HighLine

Accessories



4.6